

Mitsubishi Programmable Controller

Transition from MELSEC-A/QnA (Large Type), AnS/QnAS (Small Type) Series to Q Series Handbook

(Communications)

MELSEC-A/QnA

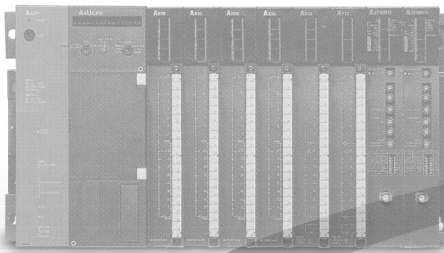

MELSEC-AnS/QnAS



MELSEC  series

Aug. 2016 Edition

● SAFETY PRECAUTIONS ●

(Read these instructions before using this equipment.)

Before using this product, please read this handbook and the relevant manuals carefully and pay full attention to safety to handle the product correctly.

In this manual, the safety precautions are classified into two levels: "⚠ WARNING" and "⚠ CAUTION".



WARNING

Indicates that incorrect handling may cause hazardous conditions, resulting in death or severe injury.



CAUTION

Indicates that incorrect handling may cause hazardous conditions, resulting in minor or moderate injury or property damage.

Under some circumstances, failure to observe the precautions given under "⚠ CAUTION" may lead to serious consequences.

Observe the precautions of both levels because they are important for personal and system safety.

Make sure that the end users read this handbook and then keep the handbook in a safe place for future reference.

[Design Precautions]

⚠ WARNING

- Configure safety circuits external to the programmable controller to ensure that the entire system operates safely even when a fault occurs in the external power supply or the programmable controller. Failure to do so may result in an accident due to an incorrect output or malfunction.
 - (1) Emergency stop circuits, protection circuits, and protective interlock circuits for conflicting operations (such as forward/reverse rotations or upper/lower limit positioning) must be configured external to the programmable controller.
 - (2) When the programmable controller detects an abnormal condition, it stops the operation and all outputs are:

	Q series module	A/AnS series module
Overcurrent or overvoltage protection of the power supply module is activated.	All outputs are turned off	All outputs are turned off
The CPU module detects an error such as a watchdog timer error by the self-diagnostic function.	All outputs are held or turned off according to the parameter setting.	All outputs are turned off

All outputs may be turned on if an error occurs in a part, such as an I/O control part, where the CPU module cannot detect any error. To ensure safety operation in such a case, provide a safety mechanism or a fail-safe circuit external to the programmable controller. For a fail-safe circuit example, refer to "General Safety Requirements" in the QCPU User's Manual (Hardware Design, Maintenance and Inspection).

- (3) Outputs may remain on or off due to a failure of an output module relay or transistor. Configure an external circuit for monitoring output signals that could cause a serious accident.

[Design Precautions]

WARNING

- In an output circuit, when a load current exceeding the rated current or an overcurrent caused by a load short-circuit flows for a long time, it may cause smoke and fire. To prevent this, configure an external safety circuit, such as a fuse.
- Configure a circuit so that the programmable controller is turned on first and then the external power supply. If the external power supply is turned on first, an accident may occur due to an incorrect output or malfunction.
- For the operating status of each station after a communication failure, refer to manuals relevant to the network. Incorrect output or malfunction due to a communication failure may result in an accident.
- When changing data of the running programmable controller from a peripheral connected to the CPU module or from a personal computer connected to an intelligent function module or special function module, configure an interlock circuit in the sequence program to ensure that the entire system will always operate safely.

For other forms of control (such as program modification or operating status change) of a running programmable controller, read the relevant manuals carefully and ensure that the operation is safe before proceeding.

Especially, when a remote programmable controller is controlled by an external device, immediate action cannot be taken if a problem occurs in the programmable controller due to a communication failure.

To prevent this, configure an interlock circuit in the sequence program, and determine corrective actions to be taken between the external device and CPU module in case of a communication failure.

CAUTION

- Do not install the control lines or communication cables together with the main circuit lines or power cables. Keep a distance of 100mm or more between them. Failure to do so may result in malfunction due to noise.
- When a device such as a lamp, heater, or solenoid valve is controlled through an output module, a large current (approximately ten times greater than normal) may flow when the output is turned from off to on. Take measures such as replacing the module with one having a sufficient current rating.
- After the CPU module is powered on or is reset, the time taken to enter the RUN status varies depending on the system configuration, parameter settings, and/or program size. Design circuits so that the entire system will always operate safely, regardless of the time.

[Installation Precautions]

CAUTION

- Use the programmable controller in an environment that meets the general specifications in the QCPU User's Manual (Hardware Design, Maintenance and Inspection). Failure to do so may result in electric shock, fire, malfunction, or damage to or deterioration of the product.
- To mount the module, while pressing the module mounting lever located in the lower part of the module, fully insert the module fixing projection(s) into the hole(s) in the base unit and press the module until it snaps into place. Incorrect mounting may cause malfunction, failure or drop of the module.
When using the programmable controller in an environment of frequent vibrations, fix the module with a screw. Tighten the screws within the specified torque range.
Undertightening can cause drop of the screw, short circuit, or malfunction.
Overtightening can damage the screw and/or module, resulting in drop, short circuit, or malfunction.
- When using an extension cable, connect it to the extension cable connector of the base unit securely. Check the connection for looseness. Poor contact may cause incorrect input or output.
- When using a memory card, fully insert it into the memory card slot. Check that it is inserted completely. Poor contact may cause malfunction.
- When using an SD memory card, fully insert it into the SD memory card slot. Check that it is inserted completely. Poor contact may cause malfunction.
- Securely insert an extended SRAM cassette into the cassette connector of a CPU module. After insertion, close the cassette cover to prevent the cassette from coming off. Poor contact may cause malfunction.
- Shut off the external power supply (all phases) used in the system before mounting or removing the module. Failure to do so may result in damage to the product.
A module can be replaced online (while power is on) on any MELSECNET/H remote I/O station or in the system where a CPU module supporting the online module change function is used.
Note that there are restrictions on the modules that can be replaced online, and each module has its predetermined replacement procedure.
For details, refer to the relevant sections in the QCPU User's Manual (Hardware Design, Maintenance and Inspection) and in the manual for the corresponding module.
- Do not directly touch any conductive parts and electronic components of the module, memory card, SD memory card, or extended SRAM cassette. Doing so can cause malfunction or failure of the module.
- When using a Motion CPU module and modules designed for motion control, check that the combinations of these modules are correct before applying power. The modules may be damaged if the combination is incorrect. For details, refer to the user's manual for the Motion CPU module.

[Wiring Precautions]

WARNING

- Shut off the external power supply (all phases) used in the system before wiring. Failure to do so may result in electric shock or damage to the product.
- After wiring, attach the included terminal cover to the module before turning it on for operation. Failure to do so may result in electric shock.

CAUTION

- Individually ground the FG and LG terminals of the programmable controller with a ground resistance of 100 ohms or less. Failure to do so may result in electric shock or malfunction.
- Use applicable solderless terminals and tighten them within the specified torque range. If any spade solderless terminal is used, it may be disconnected when the terminal screw comes loose, resulting in failure.
- Check the rated voltage and terminal layout before wiring to the module, and connect the cables correctly. Connecting a power supply with a different voltage rating or incorrect wiring may cause a fire or failure.
- Connectors for external devices must be crimped or pressed with the tool specified by the manufacturer, or must be correctly soldered. Incomplete connections may cause short circuit, fire, or malfunction.
- Securely connect the connector to the module. Poor contact may cause malfunction.
- Do not install the control lines or communication cables together with the main circuit lines or power cables. Keep a distance of 100mm or more between them. Failure to do so may result in malfunction due to noise.
- Place the cables in a duct or clamp them. If not, dangling cable may swing or inadvertently be pulled, resulting in damage to the module or cables or malfunction due to poor contact.

[Wiring Precautions]

CAUTION

- Place the cables in a duct or clamp them. If not, dangling cable may swing or inadvertently be pulled, resulting in damage to the module or cables or malfunction due to poor contact.
- Check the interface type and correctly connect the cable. Incorrect wiring (connecting the cable to an incorrect interface) may cause failure of the module and external device.
- Tighten the terminal screw within the specified torque range.
Undertightening can cause short circuit, fire, or malfunction.
Overtightening can damage the screw and/or module, resulting in drop, short circuit, or malfunction.
- Prevent foreign matter such as dust or wire chips from entering the module.
Such foreign matter can cause a fire, failure, or malfunction.
- A protective film is attached to the top of the module to prevent foreign matter, such as wire chips, from entering the module during wiring.
Do not remove the film during wiring.
Remove it for heat dissipation before system operation.
- When disconnecting the cable from the module, do not pull the cable by the cable part. For the cable with connector, hold the connector part of the cable. For the cable connected to the terminal block, loosen the terminal screw. Pulling the cable connected to the module may result in malfunction or damage to the module or cable.
- Mitsubishi programmable controllers must be installed in control panels.
Connect the main power supply to the power supply module in the control panel through a relay terminal block.
Wiring and replacement of a power supply module must be performed by maintenance personnel who is familiar with protection against electric shock. (For wiring methods, refer to the QCPU User's Manual (Hardware Design, Maintenance and Inspection)).

[Startup and Maintenance Precautions]

WARNING

- Do not touch any terminal while power is on.
Doing so will cause electric shock or malfunction.
- Correctly connect the battery connector.
Do not charge, disassemble, heat, short-circuit, solder, or throw the battery into the fire. Also, do not expose it to liquid or strong shock. Doing so will cause the battery to produce heat, explode, ignite, or leak, resulting in injury and fire.
- Shut off the external power supply for the system in all phases before cleaning the module or retightening the terminal screws or module fixing screws.
Failure to do so may result in electric shock.

CAUTION

- Before performing online operations (especially, program modification, forced output, and operation status change) for the running CPU module from the peripheral connected, read relevant manuals carefully and ensure the safety.
Improper operation may damage machines or cause accidents.
- Do not disassemble or modify the modules.
Doing so may cause failure, malfunction, injury, or a fire.
- Use any radio communication device such as a cellular phone or PHS (Personal Handy-phone System) more than 25cm away in all directions from the programmable controller.
Failure to do so may cause malfunction.
- Shut off the external power supply for the system in all phases before mounting or removing the module. Failure to do so may cause the module to fail or malfunction.
A module can be replaced online (while power is on) on any MELSECNET/H remote I/O station or in the system where a CPU module supporting the online module change function is used.
Note that there are restrictions on the modules that can be replaced online, and each module has its predetermined replacement procedure.
For details, refer to the relevant sections in the QCPU User's Manual (Hardware Design, Maintenance and Inspection) and in the manual for the corresponding module.
- After the first use of the product, do not mount/remove the module to/from the base unit, and the terminal block to/from the module, and do not insert/remove the extended SRAM cassette to/from the CPU module more than 50 times (IEC 61131-2 compliant) respectively. Exceeding the limit may cause malfunction.
- After the first use of the product, do not insert/remove the SD memory card to/from the CPU module more than 500 times. Exceeding the limit may cause malfunction.
- Do not drop or apply shock to the battery to be installed in the module.
Doing so may damage the battery, causing the battery fluid to leak inside the battery.
If the battery is dropped or any shock is applied to it, dispose of it without using.
- Before handling the module, touch a grounded metal object to discharge the static electricity from the human body.
Failure to do so may cause the module to fail or malfunction.

[Disposal Precautions] **CAUTION**

- When disposing of this product, treat it as industrial waste.
When disposing of batteries, separate them from other wastes according to the local regulations.
(For details of the battery directive in EU member states, refer to the QCPU User's Manual (Hardware Design, Maintenance and Inspection).)

[Transportation Precautions] **CAUTION**

- When transporting lithium batteries, follow the transportation regulations.
(For details of the regulated models, refer to the QCPU User's Manual (Hardware Design, Maintenance and Inspection).)

● CONDITIONS OF USE FOR THE PRODUCT ●

- (1) Mitsubishi programmable controller ("the PRODUCT") shall be used in conditions;
 - i) where any problem, fault or failure occurring in the PRODUCT, if any, shall not lead to any major or serious accident; and
 - ii) where the backup and fail-safe function are systematically or automatically provided outside of the PRODUCT for the case of any problem, fault or failure occurring in the PRODUCT.
- (2) The PRODUCT has been designed and manufactured for the purpose of being used in general industries.

MITSUBISHI SHALL HAVE NO RESPONSIBILITY OR LIABILITY (INCLUDING, BUT NOT LIMITED TO ANY AND ALL RESPONSIBILITY OR LIABILITY BASED ON CONTRACT, WARRANTY, TORT, PRODUCT LIABILITY) FOR ANY INJURY OR DEATH TO PERSONS OR LOSS OR DAMAGE TO PROPERTY CAUSED BY the PRODUCT THAT ARE OPERATED OR USED IN APPLICATION NOT INTENDED OR EXCLUDED BY INSTRUCTIONS, PRECAUTIONS, OR WARNING CONTAINED IN MITSUBISHI'S USER, INSTRUCTION AND/OR SAFETY MANUALS, TECHNICAL BULLETINS AND GUIDELINES FOR the PRODUCT.

("Prohibited Application")

Prohibited Applications include, but not limited to, the use of the PRODUCT in;

- Nuclear Power Plants and any other power plants operated by Power companies, and/or any other cases in which the public could be affected if any problem or fault occurs in the PRODUCT.
- Railway companies or Public service purposes, and/or any other cases in which establishment of a special quality assurance system is required by the Purchaser or End User.
- Aircraft or Aerospace, Medical applications, Train equipment, transport equipment such as Elevator and Escalator, Incineration and Fuel devices, Vehicles, Manned transportation, Equipment for Recreation and Amusement, and Safety devices, handling of Nuclear or Hazardous Materials or Chemicals, Mining and Drilling, and/or other applications where there is a significant risk of injury to the public or property.

Notwithstanding the above, restrictions Mitsubishi may in its sole discretion, authorize use of the PRODUCT in one or more of the Prohibited Applications, provided that the usage of the PRODUCT is limited only for the specific applications agreed to by Mitsubishi and provided further that no special quality assurance or fail-safe, redundant or other safety features which exceed the general specifications of the PRODUCTS are required. For details, please contact the Mitsubishi representative in your region.

REVISIONS

* The handbook number is given on the bottom left of the back cover.

Print Date	* Handbook Number	Revision
Apr. 2005	L(NA)08050ENG-A	First edition
Oct. 2005	L(NA)08050ENG-B	<p>[Addition]</p> <p>Appendix 1</p> <p>[Partial correction]</p> <p>Contents, Chapter 1, Section 3.1, Section 3.2.1, Section 3.3, Section 3.4, Section 3.5, Section 3.6.1, Section 3.6.2, Section 4.1, Section 4.2, Appendix 1→Appendix 2</p>
May 2006	L(NA)08050ENG-C	<p>[Addition]</p> <p>Chapter 4</p> <p>[Partial correction]</p> <p>Contents, Chapter 1, Section 2.1, Section 2.7, Section 3.1, Chapter 4→Chapter 5, Appendix 1, Appendix 2</p>
Mar. 2008	L(NA)08050ENG-D	<p>[Partial correction]</p> <p>Term revision (whole), Appendix 2.1</p>
Nov. 2012	L(NA)08050ENG-E	<p>[Model Addition]</p> <p>MELSEC-AnS/QnAS series</p> <p>[Addition]</p> <p>Section 1.2, Appendix 2</p> <p>[Partial correction]</p> <p>SAFETY PRECAUTIONS, Chapter 1 to 9, Appendix</p>
Mar. 2015	L(NA)08050ENG-F	<p>[Addition]</p> <p>Chapter 5, 6, 7, 8, 9, 10</p> <p>[Partial correction]</p> <p>SAFETY PRECAUTIONS, GENERIC TERMS AND ABBREVIATIONS, Section 1.1, 1.2, 2.1, 2.2.1, 2.2.2, 2.7, 4.1, 4.2.1, 4.2.2, 4.5.2, 11.1, Appendix 3.1, 3.2</p>
Aug. 2016	L(NA)08050ENG-G	<p>[Change]</p> <p>Chapter 11→Appendix1, Appendix 1→Appendix 2, Appendix 2→Appendix 3, Appendix 3→Appendix 4</p> <p>[Partial correction]</p> <p>Cover, Chapter 10, Appendix 4.2, 4.4, WARRANTY</p>

Japanese Handbook Version L08049-H

This handbook confers no industrial property rights or any rights of any other kind, nor does it confer any patent licenses. Mitsubishi Electric Corporation cannot be held responsible for any problems involving industrial property rights which may occur as a result of using the contents noted in this handbook.

© 2005 MITSUBISHI ELECTRIC CORPORATION

CONTENTS

SAFETY PRECAUTIONS	A - 1
CONDITIONS OF USE FOR THE PRODUCT	A - 8
REVISIONS	A - 9
CONTENTS	A - 10
GENERIC TERMS AND ABBREVIATIONS	A - 13

CHAPTER 1 INTRODUCTION **1 - 1 to 1 - 5**

1.1 Replacement of Modules Introduced in This Handbook	1 - 1
1.2 Basic Precautions	1 - 5

CHAPTER 2 SERIAL COMMUNICATION MODULE REPLACEMENT **2 - 1 to 2 - 35**

2.1 List of Serial Communication Modules to be Replaced	2 - 1
2.2 Performance Specifications Comparison	2 - 2
2.2.1 Module performance comparison	2 - 2
2.2.2 Cable specifications comparison	2 - 9
2.3 Function Comparison	2 - 13
2.4 Switch Setting Comparison	2 - 15
2.5 Program Comparison	2 - 20
2.5.1 I/O signal	2 - 20
2.5.2 Buffer memory	2 - 23
2.6 Reuse of Existing Programs	2 - 26
2.6.1 Reuse of A/AnS series programs	2 - 26
2.6.2 Reuse of QnA/QnAS series programs	2 - 28
2.7 Other Precaution	2 - 29
2.8 Program Examples	2 - 30

CHAPTER 3 ETHERNET INTERFACE MODULE REPLACEMENT **3 - 1 to 3 - 35**

3.1 List of Ethernet Interface Modules to be Replaced	3 - 1
3.2 Performance Specifications Comparison	3 - 2
3.2.1 Module performance comparison	3 - 2
3.2.2 Cable specifications comparison	3 - 6
3.3 Function Comparison	3 - 7
3.4 Switch Setting Comparison	3 - 12
3.5 Parameter Comparison	3 - 14
3.6 Program Comparison	3 - 15
3.6.1 I/O signal	3 - 15
3.6.2 Buffer memory	3 - 19
3.7 Reuse of Existing Programs	3 - 22

3.8	Other Precaution	3 - 24
3.9	Program Examples	3 - 25
3.9.1	Initial processing	3 - 26
3.9.2	Open/close processing	3 - 29
3.9.3	Communication using fixed buffer	3 - 33

CHAPTER 4 INTELLIGENT COMMUNICATION MODULE REPLACEMENT 4 - 1 to 4 - 27

4.1	List of Intelligent Communication Modules to be Replaced	4 - 1
4.2	Performance Specifications Comparison	4 - 2
4.2.1	Module performance comparison	4 - 2
4.2.2	Cable specifications comparison	4 - 5
4.3	Function Comparison	4 - 7
4.4	Switch Setting	4 - 9
4.5	Program Comparison	4 - 15
4.5.1	I/O signal	4 - 15
4.5.2	Buffer memory	4 - 21
4.6	Reuse of Existing Programs	4 - 22
4.6.1	Replacement of intelligent communication module AD51H-S3	4 - 22
4.6.2	Replacement of intelligent communication module A1SD51S	4 - 24
4.6.3	Replacement of intelligent communication module AD51-S3	4 - 27

CHAPTER 5 AS-i MASTER MODULE REPLACEMENT 5 - 1 to 5 - 10

5.1	List of AS-i Master Modules to be Replaced	5 - 1
5.2	Performance Specifications Comparison	5 - 2
5.3	Function Comparison	5 - 3
5.4	Program Comparison	5 - 4
5.4.1	I/O signals	5 - 4
5.4.2	Buffer memory	5 - 5
5.5	Program Diversion	5 - 8

CHAPTER 6 MULTIDROP LINK MODULE REPLACEMENT 6 - 1 to 6 - 3

6.1	List of Multidrop Link Modules to be Replaced	6 - 1
6.2	Replacement Configuration Examples	6 - 2

CHAPTER 7 MODBUS® MODULE REPLACEMENT 7 - 1 to 7 - 18

7.1	List of MODBUS® Modules to be Replaced	7 - 1
7.2	Performance Specifications Comparison	7 - 2
7.2.1	Module performance comparison	7 - 2
7.2.2	Cable specification comparison	7 - 3
7.3	Function Comparison	7 - 4
7.4	Switch Settings Comparison	7 - 5

7.5	Program Comparison	7 - 8
7.5.1	I/O signals	7 - 8
7.5.2	Buffer memory	7 - 11
7.6	Program Diversion	7 - 17

CHAPTER 8 DeviceNet MODULE REPLACEMENT **8 - 1 to 8 - 11**

8.1	List of DeviceNet Modules to be Replaced	8 - 1
8.2	Performance Specifications Comparison	8 - 2
8.3	Function Comparison	8 - 3
8.4	Switch Settings Comparison	8 - 4
8.5	Program Comparison	8 - 5
8.5.1	I/O signals	8 - 5
8.5.2	Buffer memory	8 - 7
8.6	Program Diversion	8 - 10

CHAPTER 9 PROFIBUS-DP MODULE REPLACEMENT **9 - 1 to 9 - 19**

9.1	List of PROFIBUS-DP Modules to be Replaced	9 - 1
9.2	PROFIBUS-DP Master Module Replacement	9 - 2
9.2.1	Performance specifications comparison	9 - 2
9.2.2	Compatible software package (configuration software)	9 - 4
9.2.3	Function comparison	9 - 5
9.2.4	Input/output signal comparison	9 - 6
9.2.5	Buffer memory	9 - 8
9.2.6	Program diversion	9 - 9
9.3	PROFIBUS-DP Slave Module Replacement	9 - 12
9.3.1	Performance specifications comparison	9 - 12
9.3.2	Function list	9 - 13
9.3.3	Parameter Setting to Master Station	9 - 14
9.3.4	Input/output signal comparison	9 - 15
9.3.5	Buffer memory comparison	9 - 17
9.3.6	Program diversion	9 - 18

CHAPTER 10 REPLACEMENT OF OTHER MODULES **10 - 1 to 10 - 2**

APPENDICES **App - 1 to App - 9**

Appendix 1	External Dimensions	App - 1
Appendix 2	Spare Parts Storage	App - 1
Appendix 3	Procedure for Replacing the A1SD51S with the QD51(-R24)	App - 2
Appendix 4	Relevant Manuals	App - 6
Appendix 4.1	Replacement Handbooks	App - 6
Appendix 4.2	A/AnS series	App - 8
Appendix 4.3	QnA/QnAS series	App - 8
Appendix 4.4	Q series	App - 9

GENERIC TERMS AND ABBREVIATIONS

Unless otherwise specified, this handbook uses the following generic terms and abbreviations.

Generic term/abbreviation	Description
■ Series	
A series	Abbreviation for large types of Mitsubishi MELSEC-A series programmable controllers
AnS series	Abbreviation for compact types of Mitsubishi MELSEC-A series programmable controllers
A/AnS series	Generic term for A series and AnS series
QnA series	Abbreviation for large types of Mitsubishi MELSEC-QnA series programmable controllers
QnAS series	Abbreviation for compact types of Mitsubishi MELSEC-QnA series programmable controllers
QnA/QnAS series	Generic term for QnA series and QnAS series
A/AnS/QnA/QnAS series	Generic term for A series, AnS series, QnA series, and QnAS series
Q series	Abbreviation for Mitsubishi MELSEC-Q series programmable controllers
■ CPU module type	
CPU module	Generic term for A series, AnS series, QnA series, QnAS series, and Q series CPU modules
Basic model QCPU	Generic term for the Q00JCPU, Q00CPU, and Q01CPU
High Performance model QCPU	Generic term for the Q02CPU, Q02HCPU, Q06HCPU, Q12HCPU, and Q25HCPU
Process CPU	Generic term for the Q02PHCPU, Q06PHCPU, Q12PHCPU, and Q25PHCPU
Redundant CPU	Generic term for the Q12PRHCPU and Q25PRHCPU
Universal model QCPU	Generic term for the Q00UJCPU, Q00UCPU, Q01UCPU, Q02UCPU, Q03UDCPU, Q04UDHCPU, Q06UDHCPU, Q10UDHCPU, Q13UDHCPU, Q20UDHCPU, Q26UDHCPU, Q03UDECPU, Q04UDEHCPU, Q06UDEHCPU, Q10UDEHCPU, Q13UDEHCPU, Q20UDEHCPU, and Q26UDEHCPU
■ CPU module model	
ACPU	Generic term for MELSEC-A series programmable controller CPUs
AnSCPU	Generic term for MELSEC-AnS series programmable controller CPUs
A/AnSCPU	Generic term for MELSEC-A series and MELSEC-AnS series programmable controller CPUs
AnNCPUP	Generic term for the A1NCPUP, A1NCPUP21/R21, A1NCPUP21-S3, A2NCPUP, A2NCPUP-S1, A2NCPUP21/R21, A2NCPUP21/R21-S1, A2NCPUP21-S3(S4), A3NCPUP, A3NCPUP21/R21, and A3NCPUP21-S3
AnACPU	Generic term for the A2ACPU, A2ACPU-S1, A3ACPU, A2ACPUP21/R21, A2ACPUP21/R21-S1, and A3ACPUP21/R21
AnUCPU	Generic term for the A2UCPU, A2UCPU-S1, A3UCPU, A4UCPU, A2USCPU, A2USCPU-S1, and A2USHCPU-S1
AnN/AnACPU	Generic term for the AnNCPUP and AnACPU
AnN/AnA/AnSCPU	Generic term for the AnNCPUP, AnACPU, and AnSCPU
QnACPU	Generic term for MELSEC-QnA series programmable controller CPUs
QnASCPU	Generic term for MELSEC-QnAS series programmable controller CPUs
QnA/QnASCPU	Generic term for MELSEC-QnA series and MELSEC-QnAS series programmable controller CPUs
A/AnS/QnA/QnASCPU	Generic term for A series, AnS series, QnA series, and QnAS series programmable controller CPUs
QCPU	Generic term for MELSEC-Q series programmable controller CPUs

Generic term/abbreviation	Description	
UC24 computer link module	Generic term for the A series computer link modules: AJ71UC24, A1SJ71UC24-R2, A1SJ71UC24-R4, A1SJ71UC24-PRF, A1SJ71C24-R2, A1SJ71C24-R4, A1SJ71C24-PRF, A2CCPUC24, and A2CCPUC24-PRF	
Serial communication module	Generic term for the following.	
	QnA series	AJ71QC24, AJ71QC24-R2, AJ71QC24-R4, A1SJ71QC24, A1SJ71QC24-R2, AJ71QC24N, AJ71QC24N-R2, AJ71QC24N-R4, A1SJ71QC24N1, A1SJ71QC24N1-R2, A1SJ71QC24N, and A1SJ71QC24N-R2
	Q series	QJ71C24N, QJ71C24N-R2, QJ71C24N-R4, QJ71C24, QJ71C24-R2
External device	Generic term for the computer connected to the serial communication module, HMI (Human Machine Interface), measuring instruments, ID modules, bar code reader, controllers, other serial communication modules, and UC24	
Computer	Generic term for the external devices which can communicate data by using MC protocol or bidirectional protocol	
Switch setting	Generic term for the intelligent function module switch setting	
Data communication function	Generic term for the MC protocol, nonprocedural protocol, bidirectional protocol, and predefined protocol	
GX Configurator-SC	Generic term for the GX Configurator-SC (SW0D5C-QSCU or later)	
RS-232 (interface)	Abbreviation for the interfaces which are compliant with RS-232	
RS-422/485 (interface)	Abbreviation for the interfaces which are compliant with RS-422 and RS-485	
Built-in Ethernet port QCPU	Generic term for the Q03UDVCPU, Q03UDECPU, Q04UDVCPU, Q04UDEHCPU, Q06UDVCPU, Q06UDEHCPU, Q10UDEHCPU, Q13UDVCPU, Q13UDEHCPU, Q20UDEHCPU, Q26UDVCPU, and Q26UDEHCPU	
Ethernet module	Generic term for the following Ethernet interface modules.	
	A/AnS series	AJ71E71N3-T, AJ71E71N-T, AJ71E71N-B5, AJ71E71N-B2, AJ71E71N-B5T, A1SJ71E71N3-T, A1SJ71E71N-T, A1SJ71E71N-B5, A1SJ71E71N-B2, A1SJ71E71N-B5T
	QnA series	AJ71QE71N3-T, AJ71QE71N-T, AJ71QE71N-B5, AJ71QE71N-B2, AJ71QE71N-B5T, A1SJ71QE71N3-T, A1SJ71QE71N-T, A1SJ71QE71N-B5, A1SJ71QE71N-B2, A1SJ71QE71N-B5T
	Q series	QJ71E71-100, QJ71E71-B5, QJ71E71-B2
A1SJ71AS92	Abbreviation for the A1SJ71AS92 AS-i master module	
QJ71AS92	Abbreviation for the QJ71AS92 AS-i master module	
Multidrop link module	Generic term for the AJ71C22(S1) when the multidrop link function is set to the AJ71UC24/A1SJ71UC24-R4/A0J2-C214S1	

1 INTRODUCTION

1.1 Replacement of Modules Introduced in This Handbook

This section outlines the replacement of the following communication modules.

- A/AnS series computer link module : Refer to CHAPTER 2.
- QnA/QnAS series serial communication module : Refer to CHAPTER 2.
- A/AnS series Ethernet interface module : Refer to CHAPTER 3.
- QnA/QnAS series Ethernet interface module : Refer to CHAPTER 3.
- A/AnS intelligent communication module : Refer to CHAPTER 4.
- AnS series AS-i master module : Refer to CHAPTER 5.
- A/AnS series multidrop link module : Refer to CHAPTER 6.
- A/AnS series MODBUS[®] module : Refer to CHAPTER 7.
- A/AnS series DeviceNet module : Refer to CHAPTER 8.
- A/AnS series PROFIBUS-DP module : Refer to CHAPTER 9.
- Other modules : Refer to CHAPTER 10.

(1) Replacement of A/AnS series computer link modules and QnA/QnAS series serial communication modules

(a) A series computer link module

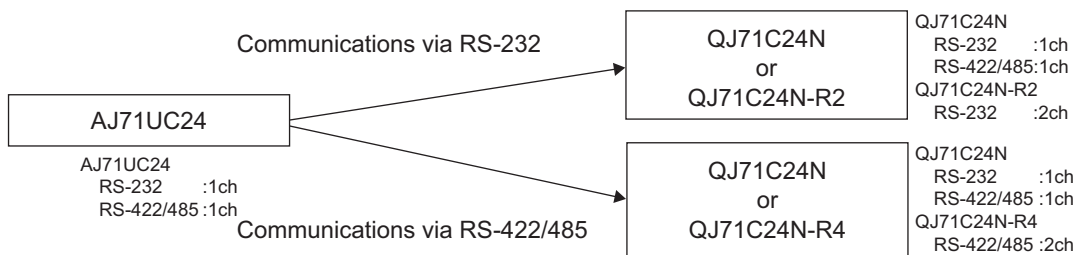

☒ Point

Q series communication modules do not have a function equivalent to the multidrop link function of the A series communication module AJ71UC24.

Refer to CHAPTER 6, configure other systems.

(b) AnS series computer link module

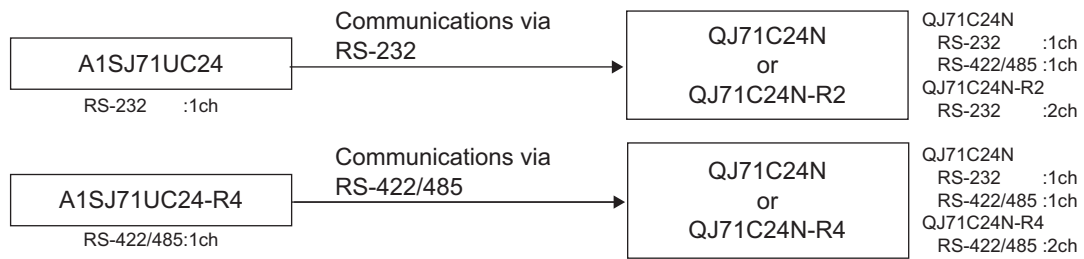

☒ Point

Q series communication modules do not have a function equivalent to the multidrop link function of the AnS series communication module A1SJ71UC24. Refer to CHAPTER 6, configure other systems.

(c) QnA series serial communication module

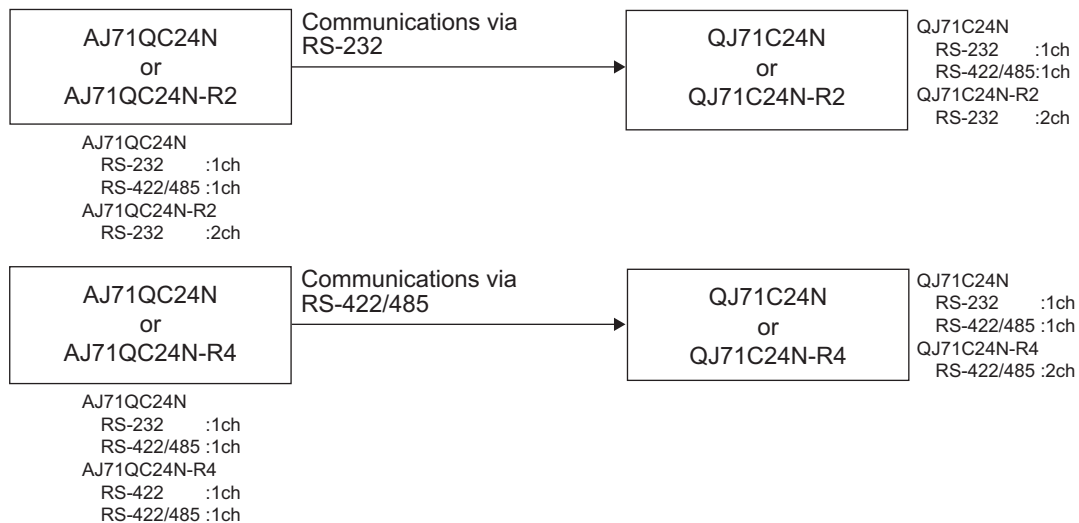

(d) QnAS series serial communication module

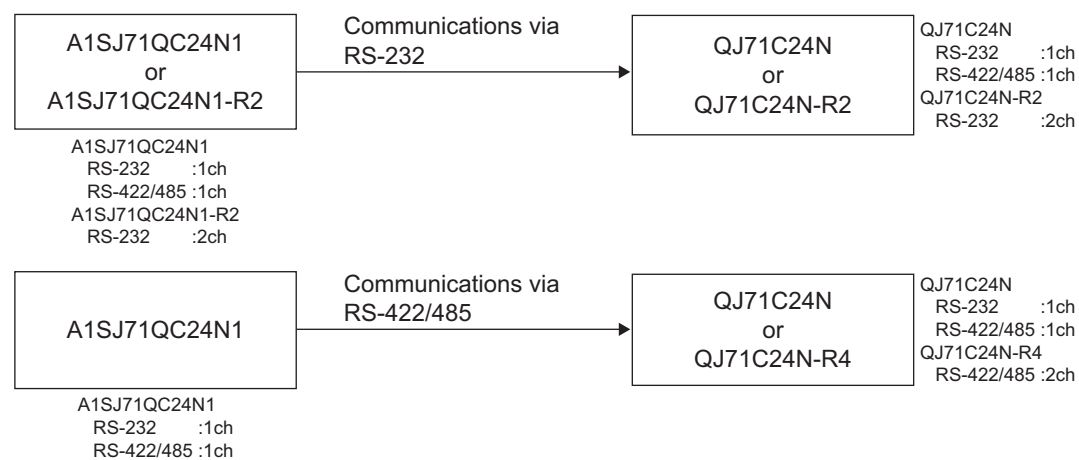

(2) Replacement of A/AnS series Ethernet interface modules and QnA/QnAS series Ethernet interface modules

(a) A series Ethernet interface module

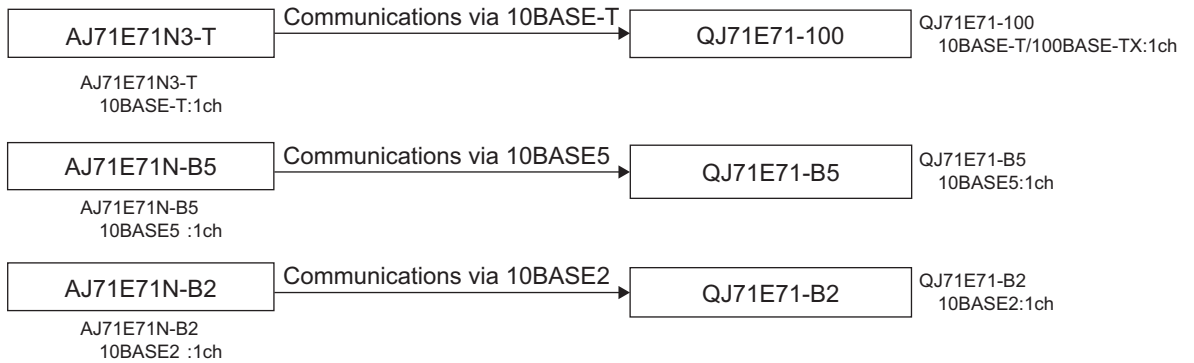

(b) AnS series Ethernet interface module

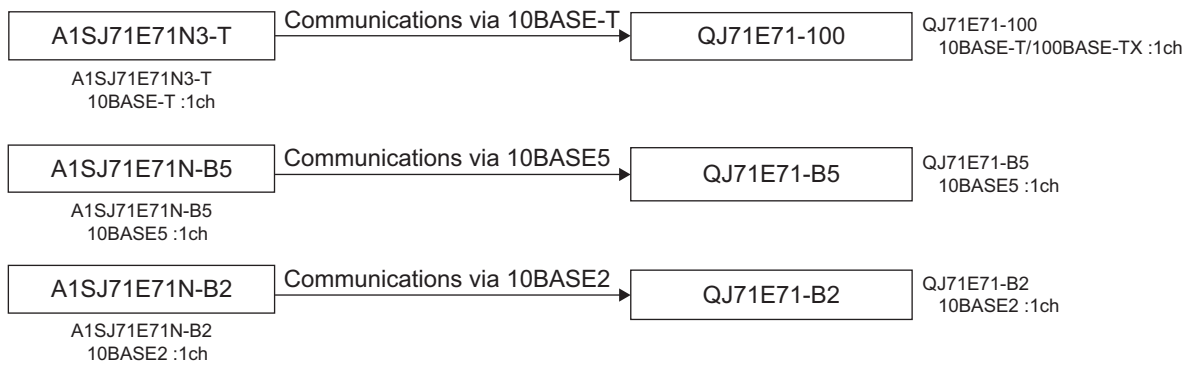

(c) QnA series Ethernet interface module

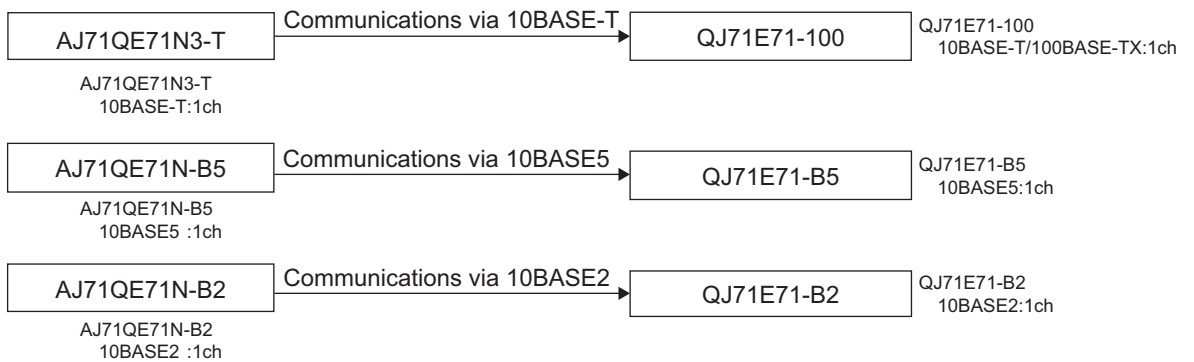

(d) QnAS series Ethernet interface module

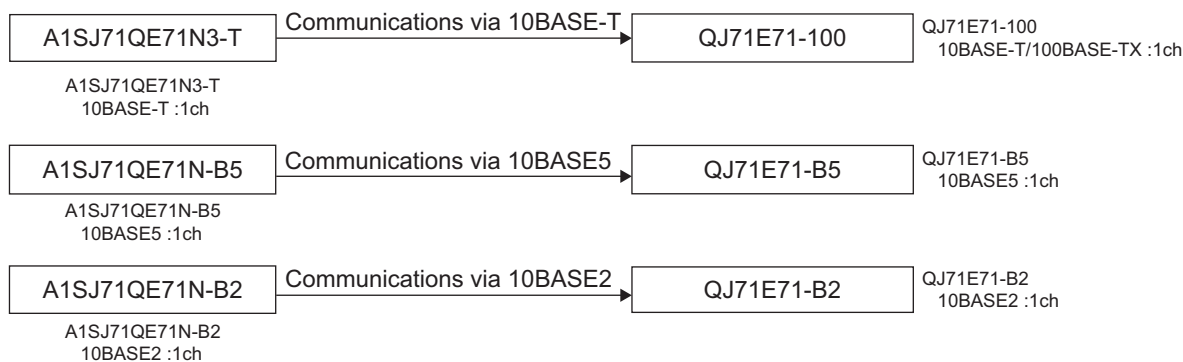

(3) Replacement of intelligent communication modules

(a) Intelligent communication module AD51H-S3

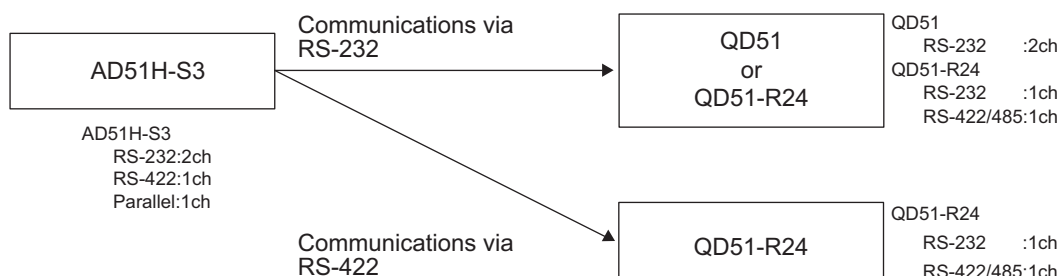

(b) Intelligent communication module AD51-S3

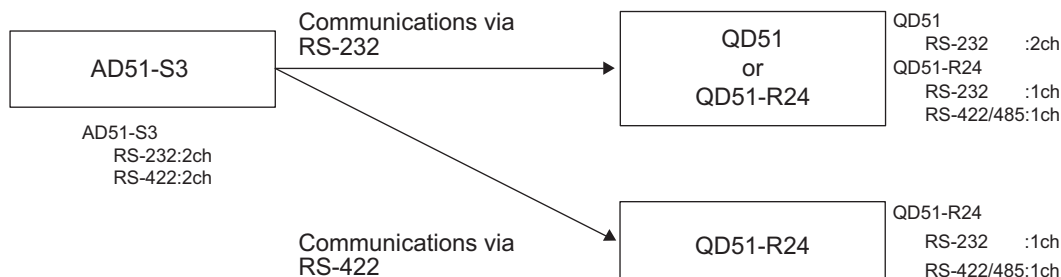

(c) Intelligent communication module A1SD51S

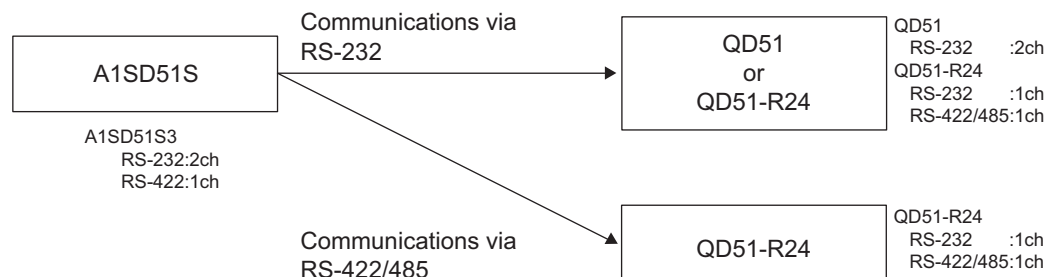

☒ Point

- Q series intelligent communication modules do not have a parallel interface. Please consider changing the external devices to RS-232/RS-422 interface devices.
- The BASIC program of the AD51-S3 is incompatible with that of the QD51/QD51-R24. Analyze the existing program to create a program with AD51H-BASIC.

1.2 Basic Precautions

(1) When using the sequence program of the A/AnS/QnA/QnAS series on the Q series

The sequence program of the A/AnS/QnA/QnAS series can be converted to be used on the Q series on GX Developer. (On GX Works2, the sequence program of the A/AnS/QnA/QnAS series cannot be converted for the Q series.)

To convert the sequence program of the A/AnS/QnA/QnAS series to be used on the Q series, use GX Developer.

(2) When creating a new sequence program for the Q series

A sequence program can be created for the Q series on GX Developer and GX Works2.

2 SERIAL COMMUNICATION MODULE REPLACEMENT

2.1 List of Serial Communication Modules to be Replaced

(1) Transition of the A series to Q series

Model to be discontinued	Alternative model	Remarks
AJ71UC24	QJ71C24N	RS-232:1ch, RS-422/485:1ch
	QJ71C24N-R2	RS-232:2ch, RS-422/485:none
	QJ71C24N-R4	RS-232:none, RS-422/485:2ch

(2) Transition of the AnS series to Q series

Model to be discontinued	Alternative model	Remarks
A1SJ71UC24-R2	QJ71C24N	RS-232:1ch, RS-422/485:1ch
	QJ71C24N-R2	RS-232:2ch, RS-422/485:none
A1SJ71UC24-R4	QJ71C24N	RS-232:1ch, RS-422/485:1ch
	QJ71C24N-R4	RS-232:none, RS-422/485:2ch
A1SCPUC24-R2*1	QCPU + QJ71C24N or QJ71C24N-R2	Select a CPU module and serial communication module as the alternative model.

*1 The A1SCPUC24-R2 is the CPU module with a built-in A1SJ71C24 function. The performance specifications of the function are the same as the A1SJ71UC24-R2. For the performance specifications comparison of the module after replacement, refer to Section 2.2.1 (2) with reading the A1SCPUC24-R2 as the A1SJ71UC24-R2.

(3) Transition of the QnA series to Q series

Model to be discontinued	Alternative model	Remarks
AJ71QC24N	QJ71C24N	RS-232:1ch, RS-422/485:1ch
AJ71QC24N-R2	QJ71C24N-R2	RS-232:2ch, RS-422/485:none
AJ71QC24N-R4	QJ71C24N-R4	RS-232:none, RS-422/485:2ch

(4) Transition of the QnAS series to Q series

Model to be discontinued	Alternative model	Remarks
A1SJ71QC24N1	QJ71C24N	RS-232:1ch, RS-422/485:1ch
A1SJ71QC24N1-R2	QJ71C24N-R2	RS-232:2ch, RS-422/485:none

2.2 Performance Specifications Comparison

2.2.1 Module performance comparison

(1) Comparison between A series and Q series

○:Compatible, △:Partial change required, ×:Incompatible

Item		Specifications		Compat- ibility	Precautions for replacement															
		A series	Q series																	
		AJ71UC24	QJ71C24N*2																	
Interface	RS-232	RS-232 compliant (D-Sub 25P) 1ch	RS-232 compliant (D-Sub 9P) 1ch	△	The connector on the connection cable must be changed.															
	RS-422/485	RS-422/485 compliant 1ch	RS-422/485 compliant (2-piece terminal block) 1ch	△	Wiring must be changed.															
Communication method	Communication using dedicated protocol*1	Half-duplex communication		○																
	Non-procedural/bidirectional communication	Full duplex communication (1:1 connection)/ Half-duplex communication (1:n, m:n connection)		○																
Synchronization method		Start stop synchronization (asynchronous method)		○																
Transmission speed		300 to 19200 bps	50 to 230400 bps	○																
Data format	Start bit	1		○																
	Data bit	7 or 8		○																
	Parity bit	1 (vertical parity)/none		○																
	Stop bit	1 or 2		○																
Access cycle	Communication using dedicated protocol	One request is processed when the mounted station programmable controller CPU executes END processing.		○																
	Non-procedural/bidirectional communication	Transmission can be executed at each send request, and reception is available at all times.		○																
Error detection	Parity check	Performed (odd/even)/none		○																
	Sum check	Performed (MC protocol/Bidirectional)/none		○																
Transmission control		<table border="1"> <tr> <td></td> <td>RS-232</td> <td>RS-422/485</td> </tr> <tr> <td>DTR/DSR (ER/DR) control</td> <td>Available</td> <td>N/A</td> </tr> <tr> <td>CD signal control</td> <td>Available</td> <td>N/A</td> </tr> <tr> <td>DC1/DC3 (Xon/Xoff) control</td> <td>Available</td> <td>Available</td> </tr> <tr> <td>DC2/DC4 control</td> <td></td> <td></td> </tr> </table>			RS-232	RS-422/485	DTR/DSR (ER/DR) control	Available	N/A	CD signal control	Available	N/A	DC1/DC3 (Xon/Xoff) control	Available	Available	DC2/DC4 control			○	
	RS-232	RS-422/485																		
DTR/DSR (ER/DR) control	Available	N/A																		
CD signal control	Available	N/A																		
DC1/DC3 (Xon/Xoff) control	Available	Available																		
DC2/DC4 control																				
Line configuration (connection)	RS-232	1:1		○																
	RS-422/485	1:1, 1:n, m:n (n:max.32, m+n:max.32)		○																
Line configuration (data communication)	Communication using dedicated protocol	1:1, 1:n, m:n (n:max.32, m+n:max.32)		○	For details on linked operation between interfaces, refer to the manual.															
	Non-procedural communication	1:1, 1:n (n:max.32)	1:1, 1:n, n:1 (n:max.32)	○																
	Bidirectional communication	1:1		○																
Transmission distance	RS-232	Max.15m		○																
	RS-422/485	Max.500m (overall distance)	Max.1200m (overall distance)	○																
No. of E ² PROM writes	Max. 100,000 times on same area in E ² PROM		Max. 100,000 times on same area in flash ROM	○																
No. of occupied I/O points	32 points/slot (I/O assignment: special 32 points)		32 points/slot (I/O assignment: intelli. 32 points)	○																

*1 On the Q series, this is called "MELSEC communication protocol" (abbrev. "MC protocol").

*2 When the AJ71UC24 uses only the RS-232 channel, it can be replaced with the QJ71C24N-R2.
When the AJ71UC24 uses only the RS-422 channel, it can be replaced with the QJ71C24N-R4.

(2) Comparison between AnS series and Q series

(a) A1SJ71UC24-R2

○:Compatible, △:Partial change required, ×:Incompatible

Item		Specifications		Compat- ibility	Precautions for replacement															
		AnS series	Q series																	
		A1SJ71UC24-R2	QJ71C24N QJ71C24N-R2																	
Interface	RS-232	RS-232 compliant (D-Sub 9P) 1ch	RS-232 compliant (D-Sub 9P) QJ71C24N: 1ch QJ71C24N-R2: 2ch	○																
	RS-422/485	-	RS-422/485 compliant (2-piece terminal block) QJ71C24N: 1ch QJ71C24N-R2: none	-																
Communication method	Communication using dedicated protocol*1	Half-duplex communication		○																
	Non-procedural/ bidirectional communication	Full duplex communication (1:1 connection)	Full duplex communication (1:1 connection)/ Half-duplex communication (1:n, m:n connection)	○																
Synchronization method		Start stop synchronization (asynchronous method)		○																
Transmission speed		300 to 19200 bps	50 to 230400 bps	○																
Data format	Start bit	1		○																
	Data bit	7 or 8		○																
	Parity bit	1 (vertical parity)/none		○																
	Stop bit	1 or 2		○																
Access cycle	Communication using dedicated protocol	One request is processed when the mounted station programmable controller CPU executes END processing.		○																
	Non-procedural/ bidirectional communication	Transmission can be executed at each send request, and reception is available at all times.		○																
Error detection	Parity check	Performed (odd/even)/none		○																
	Sum check	Performed (MC protocol/Bidirectional)/none		○																
Transmission control		<table border="1"> <tr> <td></td> <td>RS-232</td> <td>RS-422/485</td> </tr> <tr> <td>DTR/DSR (ER/DR) control</td> <td>Available</td> <td>N/A</td> </tr> <tr> <td>CD signal control</td> <td>Available</td> <td>N/A</td> </tr> <tr> <td>DC1/DC3 (Xon/Xoff) control</td> <td>Available</td> <td>Available</td> </tr> <tr> <td>DC2/DC4 control</td> <td></td> <td></td> </tr> </table>			RS-232	RS-422/485	DTR/DSR (ER/DR) control	Available	N/A	CD signal control	Available	N/A	DC1/DC3 (Xon/Xoff) control	Available	Available	DC2/DC4 control			○	
	RS-232	RS-422/485																		
DTR/DSR (ER/DR) control	Available	N/A																		
CD signal control	Available	N/A																		
DC1/DC3 (Xon/Xoff) control	Available	Available																		
DC2/DC4 control																				
Line configuration (connection)	RS-232	1:1		○																
	RS-422/485	-	1 : 1, 1 : n, m : n (n:max. 32, m+n:max.32)	○																
Line configuration (data communication)	Communication using dedicated protocol	1:1, 1:n, m:n (n:max.32, m+n:max.32)		○	For details on linked operation between interfaces, refer to the manual.															
	Non-procedural communication	1:1, 1:n (n:max.32)	1:1, 1:n, n:1 (n:max.32)	○																
	Bidirectional communication	1:1		○																
Transmission distance	RS-232	Max.15m		○																
	RS-422/485	-	Max.1200m (overall distance)	○																
No. of E ² PROM writes No. of flash ROM writes		Max. 100,000 times on same area in E ² PROM	Max. 100,000 times on same area in flash ROM	○																
No. of occupied I/O points		32 points/slot (I/O assignment: special 32 points)	32 points/slot (I/O assignment: intelli. 32 points)	○																

*1 On the Q series, this is called "MELSEC communication protocol" (abbrev. "MC protocol").

(b) A1SJ71UC24-R4

○:Compatible, △:Partial change required, ×:Incompatible

Item		Specifications		Compat- ibility	Precautions for replacement															
		AnS series	Q series																	
		A1SJ71UC24-R4	QJ71C24N QJ71C24N-R4																	
Interface	RS-232	-	RS-232 compliant (D-Sub 9P) QJ71C24N: 1ch QJ71C24N-R4: none	-																
	RS-422/485	RS-422/485 compliant 1ch	RS-422/485 compliant (2-piece terminal block) QJ71C24N: 1ch (2-piece plug-in connector socket block) QJ71C24N-R4: 2ch	△	The wiring must be changed.															
Communication method	Communication using dedicated protocol ^{*1}	Half-duplex communication		○																
	Non-procedural/bidirectional communication	Full duplex communication (1:1 connection)/ Half-duplex communication (1:n, m:n connection)		○																
Synchronization method		Start stop synchronization (asynchronous method)		○																
Transmission speed		300 to 19200 bps	50 to 230400 bps	○																
Data format	Start bit	1		○																
	Data bit	7 or 8		○																
	Parity bit	1 (vertical parity)/none		○																
	Stop bit	1 or 2		○																
Access cycle	Communication using dedicated protocol	One request is processed when the mounted station programmable controller CPU executes END processing.		○																
	Non-procedural/bidirectional communication	Transmission can be executed at each send request, and reception is available at all times.		○																
Error detection	Parity check	Performed (odd/even)/none		○																
	Sum check	Performed (MC protocol/Bidirectional)/none		○																
Transmission control		<table border="1"> <tr> <td></td> <td>RS-232</td> <td>RS-422/485</td> </tr> <tr> <td>DTR/DSR (ER/DR) control</td> <td>Available</td> <td>N/A</td> </tr> <tr> <td>CD signal control</td> <td>Available</td> <td>N/A</td> </tr> <tr> <td>DC1/DC3 (Xon/Xoff) control</td> <td>Available</td> <td>Available</td> </tr> <tr> <td>DC2/DC4 control</td> <td></td> <td></td> </tr> </table>			RS-232	RS-422/485	DTR/DSR (ER/DR) control	Available	N/A	CD signal control	Available	N/A	DC1/DC3 (Xon/Xoff) control	Available	Available	DC2/DC4 control			○	
	RS-232	RS-422/485																		
DTR/DSR (ER/DR) control	Available	N/A																		
CD signal control	Available	N/A																		
DC1/DC3 (Xon/Xoff) control	Available	Available																		
DC2/DC4 control																				
Line configuration (connection)	RS-232	-	1:1	○																
	RS-422/485	1:1, 1:n, m:n (n:max. 32, m+n:max.32)		○																
Line configuration (data communication)	Communication using dedicated protocol	1:1, 1:n, m:n (n:max.32, m+n:max.32)		○	For details on linked operation between interfaces, refer to the manual.															
	Non-procedural communication	1:1, 1:n (n:max.32)	1:1, 1:n, n:1 (n:max.32)	○																
	Bidirectional communication	1:1		○																
Transmission distance	RS-232	-	Max.15m	○																
	RS-422/485	Max.500m (overall distance)	Max.1200m (overall distance)	○																
No. of E ² PROM writes No. of flash ROM writes	Max. 100,000 times on same area in E ² PROM	Max. 100,000 times on same area in flash ROM		○																
No. of occupied I/O points	32 points/slot (I/O assignment: special 32 points)	32 points/slot (I/O assignment: intelli. 32 points)		○																

*1 On the Q series, this is called "MELSEC communication protocol" (abbrev. "MC protocol").

(3) Comparison between QnA series and Q series

○:Compatible, △:Partial change required, ×:Incompatible

Item		Specifications		Compat- ibility	Precautions for replacement																								
		QnA series	Q series																										
		AJ71QC24N AJ71QC24N-R2 AJ71QC24N-R4	QJ71C24N QJ71C24N-R2 QJ71C24N-R4																										
Interface	RS-232	RS-232 compliant (D-Sub 25P) AJ71QC24N: 1ch AJ71QC24N-R2: 2ch AJ71QC24N-R4: none	RS-232 compliant (D-Sub 9P) QJ71C24N: 1ch QJ71C24N-R2: 2ch QJ71C24N-R4: none	△	The connector on the connection cable must be changed.																								
	RS-422	RS-422 compliant (D-Sub 25P) AJ71QC24N: none AJ71QC24N-R2: none AJ71QC24N-R4: 1ch	-	×	The Q series does not have the RS-422 interface of the D-Sub 25P.																								
	RS-422/485	RS-422/485 compliant (2-piece terminal block) AJ71QC24N: 1ch AJ71QC24N-R2: none AJ71QC24N-R4: 1ch	RS-422/485 compliant (2-piece terminal block) QJ71C24N: 1ch QJ71C24N-R2: none (2-piece plug-in connector socket block) QJ71C24N-R4: 2ch	△	Wiring must be changed.																								
	Communication using dedicated protocol*1	Half-duplex communication		○																									
	Non-procedural protocol communication	Full duplex communication/Half-duplex communication		○																									
	Bidirectional protocol communication	Full duplex communication/Half-duplex communication		○																									
Synchronization method		Start stop synchronization (asynchronous method)		○																									
Transmission speed		300 to 230400 bps	50 to 230400 bps	○																									
Data format	Start bit	1		○																									
	Data bit	7 or 8		○																									
	Parity bit	1 (vertical parity)/none		○																									
	Stop bit	1 or 2		○																									
Access cycle	Communication using dedicated protocol	Processing when the mounted station programmable controller CPU performs END processing		○																									
	Non-procedural protocol communication	Transmission can be executed at each send request, and reception is available at all times.		○																									
	Bidirectional protocol communication			○																									
Error detection	Parity check	Performed (odd/even)/none		○																									
	Sum check	Performed/none		○	Select at parameter/user frame.																								
Transmission control		<table border="1"> <thead> <tr> <th></th> <th>RS-232</th> <th>RS-422</th> <th>RS-422/485</th> </tr> </thead> <tbody> <tr> <td>DTR/DSR (ER/DR) control</td> <td>Available</td> <td>Available</td> <td>N/A</td> </tr> <tr> <td>RS/CS control</td> <td>Available</td> <td>N/A</td> <td>N/A</td> </tr> <tr> <td>CD signal control</td> <td>Available</td> <td>N/A</td> <td>N/A</td> </tr> <tr> <td>DC1/DC3 (Xon/Xoff) control</td> <td>Available</td> <td>Available</td> <td>Available</td> </tr> <tr> <td>DC2/DC4 control</td> <td></td> <td></td> <td></td> </tr> </tbody> </table>			RS-232	RS-422	RS-422/485	DTR/DSR (ER/DR) control	Available	Available	N/A	RS/CS control	Available	N/A	N/A	CD signal control	Available	N/A	N/A	DC1/DC3 (Xon/Xoff) control	Available	Available	Available	DC2/DC4 control				△	The Q series does not have the RS-422 interface. Transmission control must be changed to the transmission control of the interface to be used.
	RS-232	RS-422	RS-422/485																										
DTR/DSR (ER/DR) control	Available	Available	N/A																										
RS/CS control	Available	N/A	N/A																										
CD signal control	Available	N/A	N/A																										
DC1/DC3 (Xon/Xoff) control	Available	Available	Available																										
DC2/DC4 control																													
Line configuration (connection)	RS-232	1:1		△	The Q series does not have the RS-422 interface. The interface to be used must be changed.																								
	RS-422	1:1	-																										
	RS-422/485	1:1, 1:n, m:n (n:max.32, m+n:max.32)	1:1, 1:n, n:1, m:n (n:max.32, m+n:max.32)																										

(Continued on next page)

○:Compatible, △:Partial change required, ×:Incompatible

Item		Specifications		Compat- ibility	Precautions for replacement
		QnA series	Q series		
		AJ71QC24N AJ71QC24N-R2 AJ71QC24N-R4	QJ71C24N QJ71C24N-R2 QJ71C24N-R4		
line configuration (data communication)	Communication using dedicated protocol	1:1, 1:n, m:n (n:max.32, m+n:max.32)		○	For details on linked operation between interfaces, refer to the manual.
	Non-procedural protocol communication	1:1, 1:n (n:max.32)	1:1, 1:n, n:1 (n:max.32)		
	Bidirectional protocol communication	1:1			
Transmission distance	RS-232	Max.15m		○	The Q series does not have the RS-422 interface. The interface to be used must be changed.
	RS-422	Max.1200m	-	△	
	RS-422/485	Max.1200m (overall distance)		○	
No. of E ² PROM writes No. of flash ROM writes	Max. 100,000 times on same area in E ² PROM	Max. 100,000 times on same area in flash ROM		○	
No. of occupied I/O points	32 points/slot (I/O assignment: special 32 points)	32 points/slot (I/O assignment: intelli. 32 points)		○	

*1 On the Q series, this is called "MELSEC communication protocol" (abbrev. "MC protocol").

(4) Comparison between QnAS series and Q series

○:Compatible, △:Partial change required, ×:Incompatible

Item	Specifications		Compat- ibility	Precautions for replacement																		
	QnAS series	Q series																				
	A1SJ71QC24N1 A1SJ71QC24N1-R2	QJ71C24N QJ71C24N-R2 QJ71C24N-R4																				
Interface	RS-232	RS-232 compliant (D-Sub 9P) A1SJ71QC24N1: 1ch A1SJ71QC24N1-R2: 2ch	RS-232 compliant (D-Sub 9P) QJ71C24N: 1ch QJ71C24N-R2: 2ch QJ71C24N-R4: none	○																		
	RS-422/485	RS-422/485 compliant (2-piece terminal block) A1SJ71QC24N1: 1ch A1SJ71QC24N1-R2: none	RS-422/485 compliant (2-piece terminal block) QJ71C24N: 1ch QJ71C24N-R2: none (2-piece plug-in connector socket block) QJ71C24N-R4: 2ch	△	Wiring must be changed.																	
	Communication using dedicated protocol*1	Half-duplex communication		○																		
	Non-procedural protocol communication	Full duplex communication/Half-duplex communication		○																		
	Bidirectional protocol communication	Full duplex communication/Half-duplex communication		○																		
Synchronization method	Start stop synchronization (asynchronous method)		○																			
Transmission speed	300 to 115200 bps	50 to 230400 bps	○																			
Data format	Start bit	1		○																		
	Data bit	7 or 8		○																		
	Parity bit	1 (vertical parity)/none		○																		
	Stop bit	1 or 2		○																		
Access cycle	Communication using dedicated protocol	Processing when the mounted station programmable controller CPU performs END processing		○																		
	Non-procedural protocol communication	Transmission can be executed at each send request, and reception is available at all times.		○																		
	Bidirectional protocol communication			○																		
Error detection	Parity check	Performed (odd/even)/none		○																		
	Sum check	Performed/none		○	Select at parameter/user frame.																	
Transmission control	<table border="1"> <thead> <tr> <th></th> <th>RS-232</th> <th>RS-422/485</th> </tr> </thead> <tbody> <tr> <td>DTR/DSR (ER/DR) control</td> <td>Available</td> <td>N/A</td> </tr> <tr> <td>RS/CS control</td> <td>Available</td> <td>N/A</td> </tr> <tr> <td>CD signal control</td> <td>Available</td> <td>N/A</td> </tr> <tr> <td>DC1/DC3 (Xon/Xoff) control</td> <td>Available</td> <td>Available</td> </tr> <tr> <td>DC2/DC4 control</td> <td></td> <td></td> </tr> </tbody> </table>			RS-232	RS-422/485	DTR/DSR (ER/DR) control	Available	N/A	RS/CS control	Available	N/A	CD signal control	Available	N/A	DC1/DC3 (Xon/Xoff) control	Available	Available	DC2/DC4 control			○	
	RS-232	RS-422/485																				
DTR/DSR (ER/DR) control	Available	N/A																				
RS/CS control	Available	N/A																				
CD signal control	Available	N/A																				
DC1/DC3 (Xon/Xoff) control	Available	Available																				
DC2/DC4 control																						
Line configuration (connection)	RS-232	1:1		○																		
	RS-422/485	1:1, 1:n, m:n (n:max.32, m+n:max.32)	1:1, 1:n, n:1, m:n (n:max.32, m+n:max.32)																			

(Continued on next page)

○:Compatible, △:Partial change required, ×:Incompatible

Item		Specifications		Compat- ibility	Precautions for replacement
		A1SJ71QC24N1 A1SJ71QC24N1-R2	QJ71C24N QJ71C24N-R2 QJ71C24N-R4		
line configuration (data communication)	Communication using dedicated protocol	1:1, 1:n, m:n (n:max.32, m+n:max.32)		○	For details on linked operation between interfaces, refer to the manual.
	Non-procedural protocol communication	1:1, 1:n (n:max.32)	1:1, 1:n, n:1 (n:max.32)		
	Bidirectional protocol communication	1:1			
Transmission distance	RS-232	Max.15m		○	
	RS-422/485	Max.1200m (overall distance)			
No. of E ² PROM writes		Max. 100,000 times on same area in E ² PROM	Max. 100,000 times on same area in flash ROM	○	
No. of flash ROM writes				○	
No. of occupied I/O points		32 points/slot (I/O assignment: special 32 points)	32 points/slot (I/O assignment: intelli. 32 points)	○	

*1 On the Q series, this is called "MELSEC communication protocol" (abbrev. "MC protocol").

2.2.2 Cable specifications comparison

(1) Comparison between A series and Q series

○:Compatible, △:Partial change required, ×:Incompatible

Item	Specifications		Compat- ibility	Precautions for replacement																	
	A series	Q series																			
	AJ71UC24	QJ71C24N QJ71C24N-R2 QJ71C24N-R4																			
RS-232	Cable	Use a cable that is compliant with the RS-232 standard.*1		○																	
	Cable length	Max.15m		○																	
	Applicable connector for external wiring (side of connection cable for connecting to the module)	D-Sub 25P (male, screw type) (mating screw M2.6)	D-Sub 9P*2 (male, screw type) (mating screw M2.6)	△	The connector must be changed.																
RS-422/485	Cable	<table border="1"> <thead> <tr> <th>Item</th> <th>Description</th> </tr> </thead> <tbody> <tr> <td>Cable type</td> <td>Shielded cable</td> </tr> <tr> <td>Number of pairs</td> <td>3P</td> </tr> <tr> <td>Conductor resistance (20°C)</td> <td>88.0Ω/km or less</td> </tr> <tr> <td>Insulation resistance</td> <td>10000 MΩ·km or less</td> </tr> <tr> <td>Dielectric withstand voltage</td> <td>500 VDC for 1 minute</td> </tr> <tr> <td>Electrostatic capacitance (1kHz)</td> <td>Average 60nF/km or less</td> </tr> <tr> <td>Characteristic impedance (100kHz)</td> <td>110±10Ω</td> </tr> </tbody> </table>		Item	Description	Cable type	Shielded cable	Number of pairs	3P	Conductor resistance (20°C)	88.0Ω/km or less	Insulation resistance	10000 MΩ·km or less	Dielectric withstand voltage	500 VDC for 1 minute	Electrostatic capacitance (1kHz)	Average 60nF/km or less	Characteristic impedance (100kHz)	110±10Ω	○	
		Item	Description																		
		Cable type	Shielded cable																		
		Number of pairs	3P																		
Conductor resistance (20°C)		88.0Ω/km or less																			
Insulation resistance		10000 MΩ·km or less																			
Dielectric withstand voltage		500 VDC for 1 minute																			
Electrostatic capacitance (1kHz)		Average 60nF/km or less																			
Characteristic impedance (100kHz)	110±10Ω																				
Cable length	Max.500m (overall distance)	Max.1200m (overall distance)	○																		
External wiring (side of connection cable for connecting to the module)	Connected to terminal block		○	For details on the connection method, refer to the manual.																	
	*1																				

*1 The RS-232 and RS-422/485 recommended cables are listed in the Q series serial communication module manual.

*2 Use the exclusive products listed in the Q series serial communication module manual as the connector shell of the cable to connect to the Q series serial communication module.

(2) Comparison between AnS series and Q series

○:Compatible, ◐:Partial change required, ×:Incompatible

Item	Specifications		Compat- ibility	Precautions for replacement																	
	AnS series	Q series																			
	A1SJ71UC24-R2 A1SJ71UC24-R4	QJ71C24N QJ71C24N-R2 QJ71C24N-R4																			
RS-232	Cable	Use a cable that is compliant with the RS-232 standard.*1		○																	
	Cable length	Max.15m		○																	
	Applicable connector for external wiring (side of connection cable for connecting to the module)	D-Sub 9P (male, screw type) (mating screw M2.6)	D-Sub 9P*2 (male, screw type) (mating screw M2.6)	○																	
RS-422/485	Cable	<table border="1"> <thead> <tr> <th>Item</th> <th>Description</th> </tr> </thead> <tbody> <tr> <td>Cable type</td> <td>Shielded cable</td> </tr> <tr> <td>Number of pairs</td> <td>3P</td> </tr> <tr> <td>Conductor resistance (20°C)</td> <td>88.0Ω/km or less</td> </tr> <tr> <td>Insulation resistance</td> <td>10000 MΩ·km or less</td> </tr> <tr> <td>Dielectric withstand voltage</td> <td>500 VDC for 1 minute</td> </tr> <tr> <td>Electrostatic capacitance (1kHz)</td> <td>Average 60nF/km or less</td> </tr> <tr> <td>Characteristic impedance (100kHz)</td> <td>110±10Ω</td> </tr> </tbody> </table>		Item	Description	Cable type	Shielded cable	Number of pairs	3P	Conductor resistance (20°C)	88.0Ω/km or less	Insulation resistance	10000 MΩ·km or less	Dielectric withstand voltage	500 VDC for 1 minute	Electrostatic capacitance (1kHz)	Average 60nF/km or less	Characteristic impedance (100kHz)	110±10Ω	○	
		Item	Description																		
		Cable type	Shielded cable																		
Number of pairs		3P																			
Conductor resistance (20°C)		88.0Ω/km or less																			
Insulation resistance		10000 MΩ·km or less																			
Dielectric withstand voltage		500 VDC for 1 minute																			
Electrostatic capacitance (1kHz)		Average 60nF/km or less																			
Characteristic impedance (100kHz)	110±10Ω																				
Cable length	Max.500m (overall distance)	Max.1200m (overall distance)	○																		
External wiring (side of connection cable for connecting to the module)	Connected to terminal block		○	For details on the connection method, refer to the manual.																	

*1 The RS-232 and RS-422/485 recommended cables are listed in the Q series serial communication module manual.

*2 Use the exclusive products listed in the Q series serial communication module manual as the connector shell of the cable to connect to the Q series serial communication module.

(3) Comparison between QnA series and Q series

○:Compatible, △:Partial change required, ×:Incompatible

Item	Specifications		Compat- ibility	Precautions for replacement																		
	QnA series	Q series																				
	AJ71QC24N AJ71QC24N-R2 AJ71QC24N-R4	QJ71C24N QJ71C24N-R2 QJ71C24N-R4																				
RS-232	Cable	Use a cable that is compliant with the RS-232 standard.*1		○																		
	Cable length	Max.15m		○																		
	Applicable connector for external wiring (side of connection cable for connecting to the module)	D-Sub 25P (male, screw type) (mating screw M2.6)	D-Sub 9P*2 (male, screw type) (mating screw M2.6)	△	The connector must be changed.																	
RS-422	Cable	(Same as RS-422/485)	-	△	The Q series does not have the RS-422 interface. The interface to be used must be changed.																	
	Applicable connector for external wiring (side of connection cable for connecting to the module)	D-Sub 25P (male, screw type)	Connected to the RS-232 or RS-422/485 interface.	△																		
RS-422/485	Cable	<table border="1"> <thead> <tr> <th>Item</th> <th>Description</th> </tr> </thead> <tbody> <tr> <td>Cable type</td> <td>Shielded cable</td> </tr> <tr> <td>Number of pairs</td> <td>3P</td> </tr> <tr> <td>Conductor resistance (20°C)</td> <td>88.0Ω/km or less</td> </tr> <tr> <td>Insulation resistance</td> <td>10000 MΩ·km or less</td> </tr> <tr> <td>Dielectric withstand voltage</td> <td>500 VDC for 1 minute</td> </tr> <tr> <td>Electrostatic capacitance (1kHz)</td> <td>Average 60nF/km or less</td> </tr> <tr> <td>Characteristic impedance (100kHz)</td> <td>110±10Ω</td> </tr> </tbody> </table>		Item	Description	Cable type	Shielded cable	Number of pairs	3P	Conductor resistance (20°C)	88.0Ω/km or less	Insulation resistance	10000 MΩ·km or less	Dielectric withstand voltage	500 VDC for 1 minute	Electrostatic capacitance (1kHz)	Average 60nF/km or less	Characteristic impedance (100kHz)	110±10Ω		○	
		Item	Description																			
		Cable type	Shielded cable																			
Number of pairs		3P																				
Conductor resistance (20°C)		88.0Ω/km or less																				
Insulation resistance		10000 MΩ·km or less																				
Dielectric withstand voltage		500 VDC for 1 minute																				
Electrostatic capacitance (1kHz)		Average 60nF/km or less																				
Characteristic impedance (100kHz)	110±10Ω																					
Cable length	Max.1200m (overall distance)		○																			
External wiring (side of connection cable for connecting to the module)	Connected to terminal block		○	For details on the connection method, refer to the manual.																		

*1 The RS-232 and RS-422/485 recommended cables are listed in the Q series serial communication module manual.

*2 Use the exclusive products listed in the Q series serial communication module manual as the connector shell of the cable to connect to the Q series serial communication module.

(4) Comparison between QnAS series and Q series

○:Compatible, △:Partial change required, ×:Incompatible

Item	Specifications		Compat- ibility	Precautions for replacement																	
	QnAS series	Q series																			
	A1SJ71QC24N1 A1SJ71QC24N1-R2	QJ71C24N QJ71C24N-R2 QJ71C24N-R4																			
RS-232	Cable	Use a cable that is compliant with the RS-232 standard.*1		○																	
	Cable length	Max.15m		○																	
	Applicable connector for external wiring (side of connection cable for connecting to the module)	D-Sub 9P (male, screw type) (mating screw M2.6)	D-Sub 9P*2 (male, screw type) (mating screw M2.6)	○																	
RS-422/485	Cable	<table border="1"> <thead> <tr> <th>Item</th> <th>Description</th> </tr> </thead> <tbody> <tr> <td>Cable type</td> <td>Shielded cable</td> </tr> <tr> <td>Number of pairs</td> <td>3P</td> </tr> <tr> <td>Conductor resistance (20°C)</td> <td>88.0Ω/km or less</td> </tr> <tr> <td>Insulation resistance</td> <td>10000 MΩ·km or less</td> </tr> <tr> <td>Dielectric withstand voltage</td> <td>500 VDC for 1 minute</td> </tr> <tr> <td>Electrostatic capacitance (1kHz)</td> <td>Average 60nF/km or less</td> </tr> <tr> <td>Characteristic impedance (100kHz)</td> <td>110±10Ω</td> </tr> </tbody> </table>		Item	Description	Cable type	Shielded cable	Number of pairs	3P	Conductor resistance (20°C)	88.0Ω/km or less	Insulation resistance	10000 MΩ·km or less	Dielectric withstand voltage	500 VDC for 1 minute	Electrostatic capacitance (1kHz)	Average 60nF/km or less	Characteristic impedance (100kHz)	110±10Ω	○	
		Item	Description																		
		Cable type	Shielded cable																		
		Number of pairs	3P																		
		Conductor resistance (20°C)	88.0Ω/km or less																		
		Insulation resistance	10000 MΩ·km or less																		
		Dielectric withstand voltage	500 VDC for 1 minute																		
		Electrostatic capacitance (1kHz)	Average 60nF/km or less																		
Characteristic impedance (100kHz)	110±10Ω																				
Cable length	Max.1200m (overall distance)		○																		
External wiring (side of connection cable for connecting to the module)	Connected to terminal block		○	For details on the connection method, refer to the manual.																	
	*1																				

*1 The RS-232 and RS-422/485 recommended cables are listed in the Q series serial communication module manual.

*2 Use the exclusive products listed in the Q series serial communication module manual as the connector shell of the cable to connect to the Q series serial communication module.

2.3 Function Comparison

(1) Comparison between A/AnS series and Q series

○:Compatible, △:Partial change required, ×:Incompatible

Item	Description			Compat- ibility	Precautions for replacement	Reference section
	A series	AnS series	Q series			
	AJ71UC24	A1SJ71UC24-R2 A1SJ71UC24-R4	QJ71C24N QJ71C24N-R2 QJ71C24N-R4			
Communication using dedicated protocol*1	Device memory read/write	Programmable controller CPU data is read/written to and from external devices.		△	The available commands, accessible device range, and access to another station are restricted. The program on the external device side must be changed.	Section 2.6.1
	On-demand	Data is transmitted to external devices from the programmable controller CPU.		△	Change to a sequence program that uses the dedicated instruction (ONDEMAND).	
Non-procedural communication	Data transmission Programmable controller → External device	Data is transmitted to external devices from the programmable controller CPU.		△	Change to a sequence program that uses the dedicated instructions (OUTPUT/INPUT).	
	Data reception Programmable controller ← External device	Data is transmitted from external devices.		△		
Bidirectional communication	Data transmission Programmable controller → External device	Data is transmitted to external devices from the programmable controller CPU.		△	Change to a sequence program that uses the dedicated instructions (BIDOUT/BIDIN).	
	Data reception Programmable controller ← External device	Data is transmitted from external devices.		△		
Transmission using printer function		Transmits messages (character strings) to the printer from the programmable controller CPU.		△	Change to a sequence program that uses the dedicated instruction (PRR). Transmitted by nonprocedural protocol using user frames.	
Transmission control	DTR/DSR control	Data transmission/reception with external devices is controlled by RS-232 control signals.		○		
	CD signal control			○		
	DC code control	DC codes (including Xon/Xoff) are sent/received to control data transmission/reception with external devices.		○		

*1 On the Q series, this is called "MELSEC communication protocol" (abbrev. "MC protocol").

(2) Comparison between QnA/QnAS series and Q series

○:Compatible, △:Partial change required, ×:Incompatible

Item	Description			Compat- ibility	Precautions for replacement	Reference section
	QnA series	QnAS series	Q series			
	AJ71QC24N AJ71QC24N-R2 AJ71QC24N-R4	A1SJ71QC24N1 A1SJ71QC24N1-R2	QJ71C24N QJ71C24N-R2 QJ71C24N-R4			
Communication using dedicated protocol*1	Communications in ASCII mode	Communications in dedicated protocol is performed using ASCII data.		○		
	Communications in binary mode	Communications in dedicated protocol is performed using binary data.		○		
	Device memory read/write	Programmable controller CPU data is read/written to and from external devices.		○		
	Access to another station	Data is read/written to another station's programmable controller CPU on the network system.		○	The program on the PC side sometimes must be changed according to the network to pass through.	
	On-demand	Data is transmitted to external devices from the programmable controller CPU.		○		
Non-procedural protocol communication	Data transmission/reception Programmable controller↔ External device	Data is transmitted/received between the programmable controller CPU and external devices.		○		
	Data transmission/reception in user frames	Data is transmitted or received using the data (user frames) registered to the serial communication module.		○		
	Data transmission/reception by ASCII binary conversion	Binary data is converted to ASCII data before it is transmitted. Received ASCII data is converted to binary data.		○		
Bidirectional protocol communication	Data transmission/reception Programmable controller↔ External device	Data is transmitted/received between the programmable controller CPU and external devices.		○		
	Data transmission/reception by ASCII binary conversion	Binary data is converted to ASCII data before it is transmitted. Received ASCII data is converted to binary data.		○		
Communication by dedicated link instruction (SEND/RECV, READ/WRITE, REQ)	Data is transmitted/received with another station's programmable controller CPU on a multidrop connection by link instructions.		-	×	Study the method for communicating via MELSECNET/H.	Section 2.6.2
Transmission control	DTR/DSR control	Data transmission/reception with external devices is controlled by RS-232 control signals.		○		
	RS/CS control			○		
	CD signal control			○		
	DC code control	DC codes (including Xon/Xoff) are sent/received to control data transmission/reception with external devices.		○		

*1 On the Q series, this is called "MELSEC communication protocol" (abbrev. "MC protocol").

2.4 Switch Setting Comparison

(1) Comparison between A series and Q series

○:Compatible, △:Partial change required, ×:Incompatible

Switch name	Description		Compat- ibility	Precautions for replacement	Reference section	
	A series	Q series				
	AJ71UC24					
Mode switch	Each of the interface modes' setting is determined by the data communication function to be used.		-	△	Set the switch settings in the GX Developer PLC parameter settings. Refer to Section 2.4 (3) ¹ .	
		RS-232 RS-422/485				
	0	Use not allowed				
	1 to 4	Dedicated protocol (format1 to 4) Non-procedural mode or bidirectional mode				
	5 to 8	Non-procedural mode or bidirectional mode Dedicated protocol (format1 to 4)				
	9	Non-procedural mode				
	A to D	Dedicated protocol (format1 to 4)				
	E	Use not allowed				
	F	Self-loopback test				
Station number switch		The station number of the module for when date communications is performed using dedicated protocol is set.	-	△	Section 2.7	
Transmission specification switch	SW11	Main channel setting	The target interface of transmission processing and reception processing is set.	-	-	There is no distinction with the main channel on the Q series.
	SW12	Data bit setting	The data bit length of the data to be transmitted/received is set.	-	△	Set the switch settings in the GX Developer PLC parameter settings. Refer to Section 2.4 (3) ¹ .
	SW13 to SW15	Transmission speed setting	The transmission speed for when data is to be transmitted/received is set.	-	△	
	SW16	Parity bit enable/disable setting	The parity bit ON/OFF of the data to be sent/received is set.	-	△	
	SW17	Even/odd parity setting	The type of parity bit to add to the data to be transmitted/received is set.	-	△	
	SW18	Stop bit setting	The stop bit length of the data to be transmitted/received is set.	-	△	
	SW21	Sum check enable/disable setting	The sum check code presence in dedicated protocol data communications is set.	-	△	
	SW22	Write during RUN enable/disable setting	Write during RUN enable/disable in dedicated protocol data communications is set.	-	△	
	SW23	computer link/multidrop link selection	The function of computer link module to be used is set.	-	-	There is no multidrop link function provided for the Q series.
	SW24	master/local station setting	The station type for use of multidrop link function is set.	-	-	

(2) Comparison between AnS series and Q series

(a) A1SJ71UC24-R2

○:Compatible, △:Partial change required, ×:Incompatible

Switch name	Description		Compat- ibility	Precautions for replacement	Reference section	
	AnS series	Q series				
	A1SJ71UC24-R2	QJ71C24N QJ71C24N-R2				
Mode switch	Each of the interface modes' setting is determined by the data communication function to be used.		-	△		
		RS-232 (CH1)				
	0	Use not allowed				
	1 to 4	Dedicated protocol (format1 to 4)				
	5	Non-procedural mode or bidirectional mode				
	6 to E	Use not allowed				
	F	Self-loopback test				
Station number switch		The station number of the module for when date communications is performed using dedicated protocol is set.	-	△	Set the switch settings in the GX Developer PLC parameter settings. Refer to Section 2.4 (3)*1.	
Transmission specification switch	SW03	A1ADP-SP setting	-	-		
	SW04	Write during RUN enable/disable setting	Write during RUN enable/disable in dedicated protocol data communications is set.	-		△
	SW05 to SW07	Transmission speed setting	The transmission speed for when data is to be transmitted/received is set.	-		△
	SW08	Data bit setting	The data bit length of the data to be transmitted/received is set.	-		△
	SW09	Parity bit enable/disable setting	The parity bit ON/OFF of the data to be sent/received is set.	-		△
	SW10	Even/odd parity setting	The type of parity bit to add to the data to be transmitted/received is set.	-		△
	SW11	Stop bit setting	The stop bit length of the data to be transmitted/received is set.	-		△
SW12	Sum check enable/disable setting	The sum check code presence in dedicated protocol data communications is set.	-	△		

*1 Using the A1SJ71UC24-R2 with the A1ADP-SP
 When the A1SJ71UC24-R2 with the software version X or later is used, the A1ADP-SP setting can be used. This setting is used to create a sequence program in the nonprocedural mode by using dedicated instructions for the computer link function in the AnACPU.
 When using dedicated instructions for the computer link function, switch the A1ADP-SP setting to ON. When not using them, switch the setting to OFF.
 When the A1SJ71UC24-R2 with the software version W or earlier is used, the dedicated instructions for the computer link function cannot be used.
 Create a sequence program using the FROM/TO instructions.

(b) A1SJ71UC24-R4

○:Compatible, △:Partial change required, ×:Incompatible

Switch name			Description		Compat- ibility	Precautions for replacement	Reference section	
			AnS series	Q series				
			A1SJ71UC24-R4	QJ71C24N QJ71C24N-R4				
Mode switch			Each of the interface modes' setting is determined by the data communication function to be used.		-	△		
			RS-422/485 (CH2)					
			0 to 3	Use not allowed				
			4	Non-procedural mode or bidirectional mode				
			5 to 8	Dedicated protocol (format1 to 4)				
			9 to E	Use not allowed				
			F	Self-loopback test				
Station number switch			The station number of the module for when data communications is performed using dedicated protocol is set.		-	△		
Transmission specification switch	SW01	master/local station setting	The station type for use of multidrop link function is set.		-	-	There is no multidrop link function provided for the Q series.	Section 2.7
	SW02	computer link/multidrop link selection	The function of computer link module to be used is set.		-	-		
	SW03	A1ADP-SP setting			-	-	Set the switch settings in the GX Developer PLC parameter settings. Refer to Section 2.4 (3)*1.	
	SW04	Write during RUN enable/disable setting	Write during RUN enable/disable in dedicated protocol data communications is set.		-	△		
	SW05 to SW07	Transmission speed setting	The transmission speed for when data is to be transmitted/received is set.		-	△		
	SW08	Data bit setting	The data bit length of the data to be transmitted/received is set.		-	△		
	SW09	Parity bit enable/disable setting	The parity bit ON/OFF of the data to be sent/received is set.		-	△		
	SW10	Even/odd parity setting	The type of parity bit to add to the data to be transmitted/received is set.		-	△		
	SW11	Stop bit setting	The stop bit length of the data to be transmitted/received is set.		-	△		
	SW12	Sum check enable/disable setting	The sum check code presence in dedicated protocol data communications is set.		-	△		

*1 When the A1SJ71UC24-R4 is mounted to the A1ADP-SP
 When the A1SJ71UC24-R4 with the software version X or later, the A1ADP-SP setting can be used.
 This setting is used to create a sequence program in the non-procedural mode by using the dedicated instructions for the computer link function in the AnACPU.
 When using the dedicated instructions for the computer link module, switch the A1ADP-SP setting to ON. When not using them, switch the setting to OFF.
 When the A1SJ71UC24-R4 with the software version W or earlier is used, the dedicated instructions for the computer link function cannot be used.
 Create a sequence program using the FROM/TO instructions.

(3) Comparison between QnA/QnAS series and Q series

○:Compatible, △:Partial change required, ×:Incompatible

Switch name			Description			Compat- ibility	Precautions for replacement	Reference section	
			QnA series	QnAS series	Q series				
			AJ71QC24N AJ71QC24N-R2 AJ71QC24N-R4	A1SJ71QC24N1 A1SJ71QC24N1-R2	QJ71C24N QJ71C24N-R2 QJ71C24N-R4				
Mode switch			Each of the interface modes' setting is determined by the data communication function to be used. 0: (For independent operation/linked operation) 1: Dedicated protocol (format 1) 2: Dedicated protocol (format 2) 3: Dedicated protocol (format 3) 4: Dedicated protocol (format 4) 5: Dedicated protocol (format 5) 6: Nonprocedural protocol 7: Bidirectional protocol 8 to D: Setting unavailable E: ROM/RAM/switch test F: Self-loopback test			-	△		
Station number switch			The station number of the module for when data communications is performed using dedicated protocol is set.			-	△		
Transmission specification switch	SW01	Operation setting	Operation (independent operation/linked operation) of the two interfaces is set.			-	△	Set the switch settings in the GX Developer PLC parameter settings. ⁺¹	Section 2.7
	SW02	Data bit setting	The data bit length of the data to be transmitted/received is set.			-	△		
	SW03	Parity bit enable/disable setting	The parity bit ON/OFF of the data to be sent/received is set.			-	△		
	SW04	Even/odd parity setting	The type of parity bit to add to the data to be transmitted/received is set.			-	△		
	SW05	Stop bit setting	The stop bit length of the data to be transmitted/received is set.			-	△		
	SW06	Sum check enable/disable setting	The sum check code ON/OFF in dedicated protocol/bidirectional protocol data communications is set.			-	△		
	SW07	Write during RUN enable/disable setting	Write during RUN enable/disable in dedicated protocol data communications is set.			-	△		
	SW08	Setting change enable/disable setting	Mode switching and E ² PROM write enabled/disabled are set.			-	△		
	SW09 to SW12	Transmission speed setting	The transmission speed for when data is to be transmitted/received is set.			-	△		
	SW13 to SW15	-	(All switches are set to OFF.)			-	-		

*1 The Q series serial communication module switch setting is set in the GX Developer PLC parameter settings.

Switch setting for I/O and intelligent function module

Input format: HEX

	Slot	Type	Model name	Switch 1	Switch 2	Switch 3	Switch 4	Switch 5
0	PLC	PLC						
1	0(*-0)	Intell.	QJ71C24N	07C0	0001	07C0	0001	0000
2	1(*-1)							
3	2(*-2)							
4	3(*-3)							
5	4(*-4)							
6	5(*-5)							
7	6(*-6)							
8	7(*-7)							
9	8(*-8)							
10	9(*-9)							
11	10(*-10)							
12	11(*-11)							
13	12(*-12)							
14	13(*-13)							
15	14(*-14)							

End Cancel

2.5 Program Comparison

2.5.1 I/O signal

(1) Comparison between A/AnS series and Q series

There is no compatibility in the I/O signal assignments between the A/AnS series and the Q series. Make a new sequence program.

○:Compatible, △:Partial change required, ×:Incompatible

Input signal	Signal name		Compat- ibility	Precautions for replacement
	A series	AnS series		
	AJ71UC24	A1SJ71UC24-R2 A1SJ71UC24-R4		
Xn0	Transmission complete		△	On the Q series, Xn0, Xn1, Xn7, and Xn8 are used as the transmission complete signals.
Xn1	Receive data read request		△	On the Q series, Xn3, Xn4, XnA, and XnB are used as the read request, receive data, and read request signals.
Xn2	Global signal		△	On the Q series, X(n+1)A and X(n+1)B are used as global signals.
Xn3	On-demand in execution		△	Transmission complete of on-demand data is confirmed by the complete device of the ONDEMAND instruction.
Xn4	Computer link module Transmission sequence status		△	The status is confirmed by the transmission sequence state storage area (addresses: 597(256 _H), 613(265 _H)) in buffer memory.
Xn5				
Xn6				
Xn7	Computer link module ready		△	On the Q series, X(n+1)E is used as the ready signal.
Xn8	Use prohibited		△	On the Q series, Xn8 is used as the abnormal completion of transmission signal.
Xn9	Mode switching complete		△	On the Q series, Xn6 is used as the mode switching complete signal.
XnA	Use prohibited		△	On the Q series, XnA and XnB are used as signals for various applications. (Refer to Section 2.5.1 (2).)
XnB				
XnC				
XnD	Watchdog timer		△	On the Q series, X(n+1)F is used as the watchdog timer signal.
XnE to X(n+1)F	Use prohibited		△	On the Q series, XnE to X(n+1)F are used as signals for various applications. (Refer to Section 2.5.1 (2).)

Output signal	Signal name		Compat- ibility	Precautions for replacement
	A series	AnS series		
	AJ71UC24	A1SJ71UC24-R2 A1SJ71UC24-R4		
Yn0 to YnF	Use prohibited		△	On the Q series, Yn0 to YnF are used as signals for various applications. (Refer to Section 2.5.1 (2).)
Y(n+1)0	Send request		△	On the Q series, Yn0 and Yn7 are used as the send request signals.
Y(n+1)1	Receive data read complete		△	On the Q series, Yn1 and Yn8 are used as the receive data read complete signals.
Y(n+1)2 to Y(n+1)8	Use prohibited		△	On the Q series, Y(n+1)2 to Y(n+1)8 are used as signals for various applications. (Refer to Section 2.5.1 (2).)
Y(n+1)9	Mode switching request		△	On the Q series, Yn2 and Yn9 are used as the mode switching request signals.
Y(n+1)A	Use prohibited		○	
Y(n+1)B				
Y(n+1)C				
Y(n+1)D	Use prohibited		△	On the Q series, Y(n+1)C is used as the system setting default request signal.
Y(n+1)E	Use prohibited		○	
Y(n+1)F				

(2) Comparison between QnA/QnAS series and Q series

○:Compatible, △:Partial change required, ×:Incompatible

Input signal	Signal name			Compat- ibility	Precautions for replacement	
	QnA series	QnAS series	Q series			
	AJ71QC24N AJ71QC24N-R2 AJ71QC24N-R4	A1SJ71QC24N1 A1SJ71QC24N1-R2	QJ71C24N QJ71C24N-R2 QJ71C24N-R4			
Xn0	CH1	Normal completion of transmission	CH1	Normal completion of transmission	○	
Xn1		Abnormal completion of transmission		Abnormal completion of transmission	○	
Xn2		Transmission processing in progress		Transmission processing in progress	○	
Xn3		Receive data read request		Receive data read request	○	
Xn4		Receive error detection		Receive error detection	○	
Xn5	(System use)		(System use)	○		
Xn6	CH1 mode switching		CH1 mode switching	○		
Xn7	CH2	Normal completion of transmission	CH2	Normal completion of transmission	○	
Xn8		Abnormal completion of transmission		Abnormal completion of transmission	○	
Xn9		Transmission processing in progress		Transmission processing in progress	○	
XnA		Receive data read request		Receive data read request	○	
XnB		Receive error detection		Receive error detection	○	
XnC	(System use)		(System use)	○		
XnD	CH2 mode switching		CH2 mode switching	○		
XnE	CH1 ERR.LED ON		CH1 error.	○		
XnF	CH2 ERR.LED ON		CH2 error.	○		
X(n+1)0	Modem initialization completion		Modem initialization completion	○		
X(n+1)1	Dialing		Dialing	○		
X(n+1)2	Connecting		Line connection	○		
X(n+1)3	Abnormal completion of initialization/connection		Initialization, line connection failure	○		
X(n+1)4	Modem disconnection completion		Line disconnection completion	○		
X(n+1)5	Normal completion of notification		Normal completion of notification	○		
X(n+1)6	Abnormal completion of notification		Abnormal completion of notification	○		
X(n+1)7	E ² PROM read complete		Flash ROM read complete	○		
X(n+1)8	E ² PROM write complete		Flash ROM write complete	○		
X(n+1)9	E ² PROM system setting write complete		Flash ROM system setting completion	○		
X(n+1)A	CH1 global signal		CH1 global signal	○		
X(n+1)B	CH2 global signal		CH2 global signal	○		
X(n+1)C	System setting default completion		System setting default completion	○		
X(n+1)D	(System use)		(System use)	○		
X(n+1)E	QC24N ready signal (accessible)		C24 ready signal	○		
X(n+1)F	Watchdog timer		Watchdog timer	○		

○:Compatible, △:Partial change required, ×:Incompatible

Output signal	Signal name			Compat- ibility	Precautions for replacement	
	QnA series	QnAS series	Q series			
	AJ71QC24N AJ71QC24N-R2 AJ71QC24N-R4	A1SJ71QC24N1 A1SJ71QC24N1-R2	QJ71C24N QJ71C24N-R2 QJ71C24N-R4			
Yn0	CH1	Send request	CH1	Send request	○	
Yn1		Receive data read complete		Receive data read complete	○	
Yn2		Mode switching request		Mode switching request	○	
Yn3	Use prohibited		Use prohibited		○	
Yn4						
Yn5						
Yn6						
Yn7	CH2	Send request	CH2	Send request	○	
Yn8		Receive data read complete		Receive data read complete	○	
Yn9		Mode switching request		Mode switching request	○	
YnA	Use prohibited		Use prohibited		○	
YnB						
YnC						
YnD						
YnE	CH1 ERR.LED OFF request		CH1 side error information initialization request		○	
YnF	CH2 ERR.LED OFF request		CH2 side error information initialization request		○	
Y(n+1)0	Modem initialization request		Modem initialization request		○	
Y(n+1)1	Connection request		Line connection request		○	
Y(n+1)2	Modem disconnection request		Line disconnection request		○	
Y(n+1)3	Use prohibited		Use prohibited		○	
Y(n+1)4	Notification issue request		Notification issue request		○	
Y(n+1)5	Use prohibited		Use prohibited		○	
Y(n+1)6						
Y(n+1)7	E ² PROM read request		Flash ROM read request		○	
Y(n+1)8	E ² PROM write request		Flash ROM write request		○	
Y(n+1)9	E ² PROM system setting write request		Flash ROM system setting request		○	
Y(n+1)A	Use prohibited		Use prohibited		○	
Y(n+1)B						
Y(n+1)C	System setting default request		System setting default request		○	
Y(n+1)D	Use prohibited		Use prohibited		○	
Y(n+1)E						
Y(n+1)F						

2.5.2 Buffer memory

(1) Comparison between A/AnS series and Q series

There is no compatibility in the buffer memory assignments between the A/AnS series and the Q series. Make a new sequence program.

The table below shows the main assignment areas for the initial settings and for transmission/reception.

O:Compatible, Δ:Partial change required, ×:Incompatible

Buffer memory address		Buffer memory name		Compat- ibility	Precautions for replacement
HEX	DEC	A series	AnS series		
		AJ71UC24	A1SJ71UC24-R2 A1SJ71UC24-R4		
0 _H	0	Non-procedural send data count storage area		Δ	On the Q series, the area of address 400 _H , 800 _H (1024, 2048) is used as the send data count specification area.
1 _H to 7F _H	1 to 127	Send data storage area		Δ	On the Q series, the area from address 401 _H , 801 _H (1025, 2049) is used as the send data specification area.
80 _H	128	Non-procedural receive data count storage area		Δ	On the Q series, the area of address 600 _H , A00 _H (1536, 2560) is used as the receive data count specification area.
81 _H to FF _H	129 to 255	Receive data storage area		Δ	On the Q series, the area from address 601 _H , A01 _H (1537, 2561) is used as the receive data storage area.
100 _H	256	Non-procedural receive end code specification		Δ	On the Q series, the area of address A5 _H , 145 _H (165, 325) is used as the receive end code specification area.
to	to	to		Δ	On the Q series, the area from address 101 _H (257) onward is used for various applications.
103 _H	259	Non-procedural word/byte specification area		Δ	On the Q series, the area of 96 _H , 136 _H (150, 310) is used as the word/byte unit specification area.*1
104 _H	260	Non-procedural send buffer memory head address specification area		Δ	On the Q series, the area of address A2 _H , 142 _H (162, 322) is used as the send buffer memory head address specification area.*1
105 _H	261	Non-procedural send buffer memory length specification area		Δ	On the Q series, the area of address A3 _H , 143 _H (163, 323) is used as the send buffer memory length specification area.*1
106 _H	262	Non-procedural receive buffer memory head address specification area		Δ	On the Q series, the area of address A6 _H , 146 _H (166, 326) is used as the receive buffer memory head address specification area.*1
107 _H	263	Non-procedural receive buffer memory length specification area		Δ	On the Q series, the area of address A7 _H , 147 _H (167, 327) is used as the receive buffer memory buffer memory length specification area.*1
108 _H	264	Non-procedural receive end data count specification area		Δ	On the Q series, the area of address A4 _H , 144 _H (164, 324) is used as the receive end data count specification area.*1
109 _H	265	On-demand buffer memory head address specification area		Δ	On the Q series, the area of address A0 _H , 140 _H (160, 320) is used as the on-demand buffer memory head address specification area.*1
10A _H	266	On-demand length specification area		Δ	On the Q series, the area of address A1 _H , 141 _H (161, 321) is used as the on-demand data length specification area.*1
10B _H	267	RS-232 CD terminal check setting area		Δ	On the Q series, the area of 97 _H , 137 _H (151, 311) is used as the CD terminal check specification area.*1
10C _H to DFF _H	268 to 3583	-		Δ	On the Q series, the area from address 10C _H (152) onward is used for various applications.

*1 Make the initial setting on the utility package (GX Configurator-SC).

(2) Comparison between QnA/QnAS series and Q series

The table below shows the main assignment areas for the initial settings and for transmission/reception.

○:Compatible, △:Partial change required, ×:Incompatible

Buffer memory address		Buffer memory name			Compat- ibility	Precautions for replacement
HEX	DEC	QnA series	QnAS series	Q series		
		AJ71QC24N AJ71QC24N-R2 AJ71QC24N-R4	A1SJ71QC24N1 A1SJ71QC24N1-R2	QJ71C24N QJ71C24N-R2 QJ71C24N-R4		
0 _H	0	System setting area		LED, communication error clear area	-	
		CH1 LED OFF, communication error clear request area		CH1 LED OFF, communication error clear request area	○	
to	to	to		to	○	
2E _H to 38 _H	46 to 56	Modem Function area (For initial setting)		Modem function specification-1 area (For initial setting)	○	
39 _H to 8F _H	57 to 143	System area (use prohibited)		System area (use prohibited)	○	
90 _H , 130 _H	144, 304	Mode switching area		Mode switching specification area	○	
91 _H , 131 _H	145, 305	System area (use prohibited)		RS-DTR signal status specification area	△	Use the default value.
92 _H , 132 _H	146, 306	DTR/DSR, DC control specification area		DTR/DSR, DC control specification area	○	
93 _H , 133 _H	147, 307	DC1/DC3 code specification area		DC1/DC3 code specification area	○	
94 _H , 134 _H	148, 308	DC2/DC4 code specification area		DC2/DC4 code specification area	○	
95 _H , 135 _H	149, 309	Word/byte specification area		Word/byte specification area	○	
96 _H , 136 _H	150, 310	RS-232 CD terminal check setting area		RS-232 CD terminal check setting area	○	
97 _H , 137 _H	151, 311	to		to	○	
A0 _H , 140 _H	160, 320	On-demand buffer memory head address specification area		On-demand buffer memory head address specification area	○	
A1 _H , 141 _H	161, 321	On-demand data length specification area		On-demand data length specification area	○	
A2 _H , 142 _H	162, 322	Send buffer memory head address specification area		Send buffer memory head address specification area	○	
A3 _H , 143 _H	163, 323	Send buffer memory length specification area		Send buffer memory length specification area	○	
A4 _H , 144 _H	164, 324	Receive end data count specification area		Receive end data count specification area	○	
A5 _H , 145 _H	165, 325	Receive end code specification area		Receive end code specification area	○	
A6 _H , 146 _H	166, 326	receive buffer memory head address specification area		receive buffer memory head address specification area	○	
A7 _H , 147 _H	167, 327	receive buffer memory length specification area		receive buffer memory length specification area	○	
to	to	to		to	○	
200 _H to 220 _H	512 to 544	System information area		System information area	○	
221 _H to 23D _H	545 to 573	Modem function area		Modem function area	○	
23E _H	574	System information area		System area (use prohibited)	-	
23F _H to 24E _H	575 to 590	System area (use prohibited)		station No. setting check area	○	
24F _H	591	to		to	○	
to	to	to		to	○	
3FF _H	1023	System area (use prohibited)		System area (use prohibited)	○	
400 _H	1024	CH1 transfer buffer memory		CH1 transfer buffer memory	-	
		Send data count specification area		Send data count specification area	○	
401 _H to 5FF _H	1025 to 1535	Send data specification area		Send data specification area	○	
600 _H	1536	Receive data count specification area		Receive data count specification area	○	
601 _H to 7FF _H	1537 to 2047	Receive data storage area		Receive data storage area	○	

(Continued on next page)

○:Compatible, △:Partial change required, ×:Incompatible

Buffer memory address		Buffer memory name			Compat- ibility	Precautions for replacement
HEX	DEC	QnA series	QnAS series	Q series		
		AJ71QC24N AJ71QC24N-R2 AJ71QC24N-R4	A1SJ71QC24N1 A1SJ71QC24N1-R2	QJ71C24N QJ71C24N-R2 QJ71C24N-R4		
800 _H	2048	CH2 transfer buffer memory		CH2 transfer buffer memory	-	
		Send data count specification area		Send data count specification area	○	
801 _H to 9FF _H	2049 to 2559	Send data specification area		Send data specification area	○	
A00 _H	2560	Receive data count specification area		Receive data count specification area	○	
A01 _H to BFF _H	2561 to 3071	Receive data storage area		Receive data storage area	○	
C00 _H to 1AFF _H	3072 to 6911	User free area		User free area	○	
1B00 _H to 1FF6 _H	6912 to 8182	User frame registration area		User registration area	○	
1FF7 _H to 1FFF _H	8183 to 8191	System area (use prohibited)		System area (use prohibited)	○	
2000 _H	8192	-		Flash ROM write enable/disable specification area	△	An additional sequence program is required depending on the functions to be used.
2001 _H to 7FFF _H	8193 to 32767			(Area for new function)		

2.6 Reuse of Existing Programs

2.6.1 Reuse of A/AnS series programs

Data communications between programmable controller CPU and external device, and between programmable controller CPUs that was performed by the A/AnS series computer link module can also be performed using Q series serial communication modules.

The following shows a description of how to reuse programs for A/AnS series computer link module for use on a Q series serial communication module at replacement of modules.

Item	Relevant device	Description	Remarks
Initial setting	Programmable controller CPU	[Initial Setting on the Utility Package] Make the initial setting on the utility package (GX Configurator-SC). [Deleting the initial setting program] Delete the initial setting program. [Setting the sum check code of the bidirectional protocol] When appending messages with the sum check code in bidirectional protocol communications, set the switches in the GX Developer PLC parameters.	Refer to the Q Corresponding Serial Communication Module User's Manual (Basic).
Communication using dedicated protocol (MC protocol communication)	Programmable controller CPU	[Access to another station] When accessing other station's programmable controller CPU via MELSECNET/H, set "Valid module during other station access" in the GX Developer network parameters. [Data transmission by the on-demand function] Change to a sequence program that uses the dedicated instruction (ONDEMAND).	<ul style="list-style-type: none"> Refer to the GX Developer Operating Manual. Refer to the Q Corresponding Serial Communication Module User's Manual (Basic). Refer to the MELSEC communication protocol reference manual.
	Communication target device	[Accessing the programmable controller CPU] The available commands, accessible device range, and access to another station are restricted.*1 *2 [Access to another station] Another station cannot be accessed via the data link system (MELSECNET(II), MELSECNET/B).	
Non-procedural communication (Non-procedural protocol communication)	Programmable controller CPU	[Transmission/reception of data] Change to a sequence program that uses the dedicated instructions (INPUT, OUTPUT).	Refer to the Q Corresponding Serial Communication Module User's Manual (Basic).
	Communication target device	[Transmission of data] When receiving by the receive end code on the programmable controller CPU side, transmit the data (default, CR+LF (codes: 0D _H , 0A _H)) of the end code at the end of the data to be transmitted to the programmable controller CPU.*3	
Bidirectional communication (Bidirectional protocol communication)	Programmable controller CPU	[Transmission/reception of data] Change to a sequence program that uses the dedicated instructions (BIDIN, BIDOUT).	
Transmission using printer function	Programmable controller CPU	[Printing messages on a printer] When messages*4 were being printed on a printer, create a transmission program using user frames of the Q series serial communication module.*5 Delete programs that use the regular printer function.	Refer to the Q Corresponding Serial Communication Module User's Manual (Application).
Others	Programmable controller CPU	[Assignment of I/O signals] There is no compatibility in the I/O signal (X/Y) assignments between the A/AnS series and the Q series. Check the I/O signals (X/Y) in use, and correct the program.	Refer to the Q Corresponding Serial Communication Module User's Manual (Basic).
	Programmable controller CPU and Communication target device	[Assignment of buffer memory] There is no compatibility in the buffer memory assignments between the A/AnS series and the Q series. Check the target buffer memories and addresses of the data to read/write, and correct the program.	

- *1 Only accessing of device memory on the programmable controller CPU is available.
Accessible device range is the same as that on the A/AnS series programmable controller CPU.
The following devices cannot be accessed from external devices:
 - Devices newly added on by QCPU
 - Latch relays (L) and step relays (S)

*In the case of QCPU, latch relays (L) and step relays (S) are different devices from internal relays (M). Internal relays, however, are accessed whichever of these relays is specified.

 - File registers (R)

To use a function other than accessing of device memories, access using the new commands for the Q series serial communication module.
(Create a new program.)
- *2 The following devices in special relays (M9000 onwards) and special registers (D9000 onwards) are accessed:
 - SD1000 to SD1255 are accessed by specifying D9000 to D9255.
 - SM1000 to SM1255 are accessed by specifying M9000 to M9255.
- *3 In the same way as when an A/AnS series computer link module is used, any receive end code can be registered to a Q series serial communication module, and data can be transmitted to external devices as a result of this.
- *4 Messages that are handled by an A/AnS series computer link module become user frames on a Q series serial communication module.
- *5 Messages (user frames) can be registered on the utility package (GX Configurator-SC).
Messages are transmitted by the dedicated instruction (PRR).

2.6.2 Reuse of QnA/QnAS series programs

Data communications between programmable controller CPU and external device, and between programmable controller CPUs that was performed by the QnA/QnAS series serial communication module can also be performed using Q series serial communication modules.

The following shows a description of how reuse programs for a QnA/QnAS series serial communication module for use on a Q series serial communication module at replacement of module.

Item	Relevant device	Description	Remarks
Communication using link instruction	Programmable controller CPU	[Data communications by link instructions] Link instructions are not provided with a function for performing data communications with another stations programmable controller CPU on a multidrop connection. The communications method must be changed (e.g. communications via MELSECNET/H). Delete the data communications program using the link instruction.	
Others	Communication target device	[Data communications on the RS-422/485 interface] The precautions during data communications are the same as when a QnA/QnAS series serial communication module is used. First check operation of the RS-422/485 interface on the programmable controller CPU side, and then insert a wait time, etc. to adjust the data transmission/reception timing.	Refer to the Q Corresponding Serial Communication Module User's Manual (Basic).

2.7 Other Precaution

The following shows the precautions relating to Q series serial communication modules when A/AnS/QnA/QnAS series programmable controllers are replaced with Q series programmable controllers.

(1) About processing time

The processing time for data communications differs between the A/AnS/QnA/QnAS and Q series modules.

For this reason, some data communications timing may be also different. If necessary, adjust the timing by inserting a wait time, for example.

For actual details on processing times, refer to the manual for the respective module.

(2) About switch settings

When using a Q series serial communication module, be sure to set the operation mode, station number and transmission specifications in the following parameter setting screen on GX Developer.

- "Switch setting for intelligent function module" screen

The Q series serial communication module does not have setting switches for setting the mode setting, station number setting and transmission specifications setting.

(3) About the RS-422 interface

Q series communication modules do not have the connector specifications RS-422 interface (CH1) that is available on the QnA series communication module AJ71QC24N-R4.

Use the RS-232 interface or terminal block specifications RS-422/485 interface to connect to external devices.

- Replacement with the RS-232

The RS-232/RS-422 converter is required outside.

- Replacement with the RS-422/485

The transmission control cannot be used.

The wiring change is required so that the transmission control at an external device side is always on.

(4) About data communications on the RS-422/485 interface

The precautions during data communications on the RS-422/485 interface are the same as when a QnA/QnAS series serial communication module is used. When external devices may receive the wrong data, attach a pullup/pulldown transistor on the external device side.

2.8 Program Examples

The following shows an example of how to change the nonprocedural communications program on the A/AnS series computer link module for use on a Q series serial communication module when replacing an A/AnS series programmable controller with a Q series programmable controller.

When applying the program examples introduced in this section to an actual program, sufficiently study if there will be any problem in control on the target system.

(1) Program example of A/AnS series computer link module

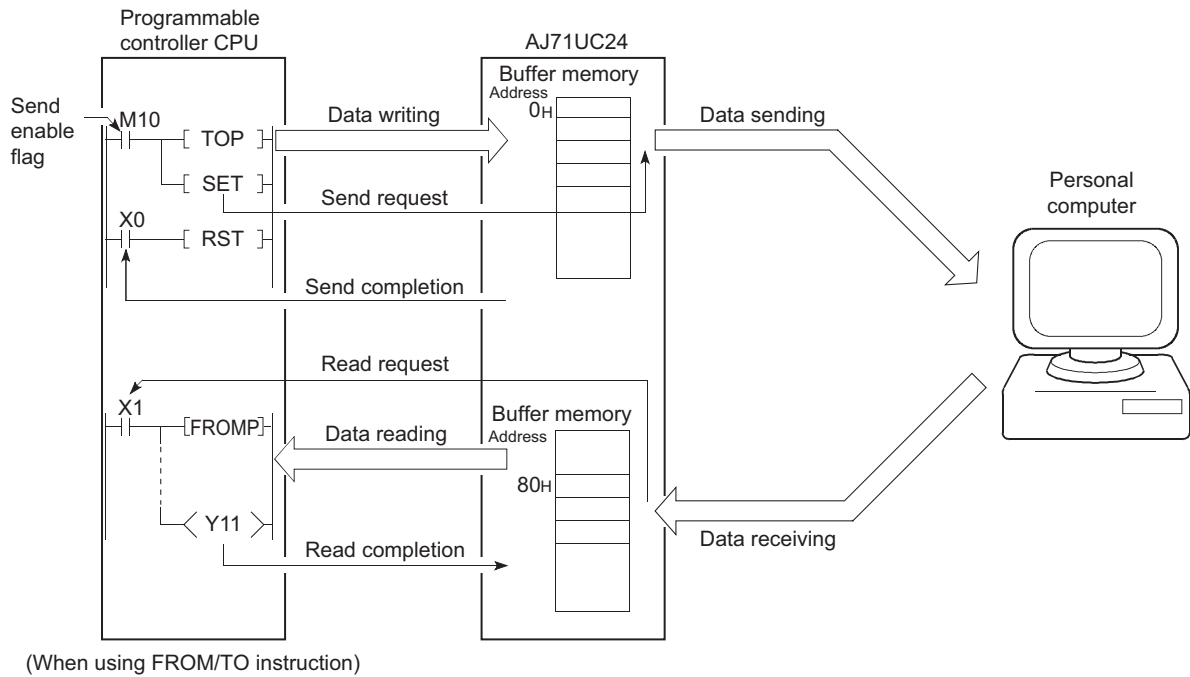

(a) When using application instruction (FROM/TO)

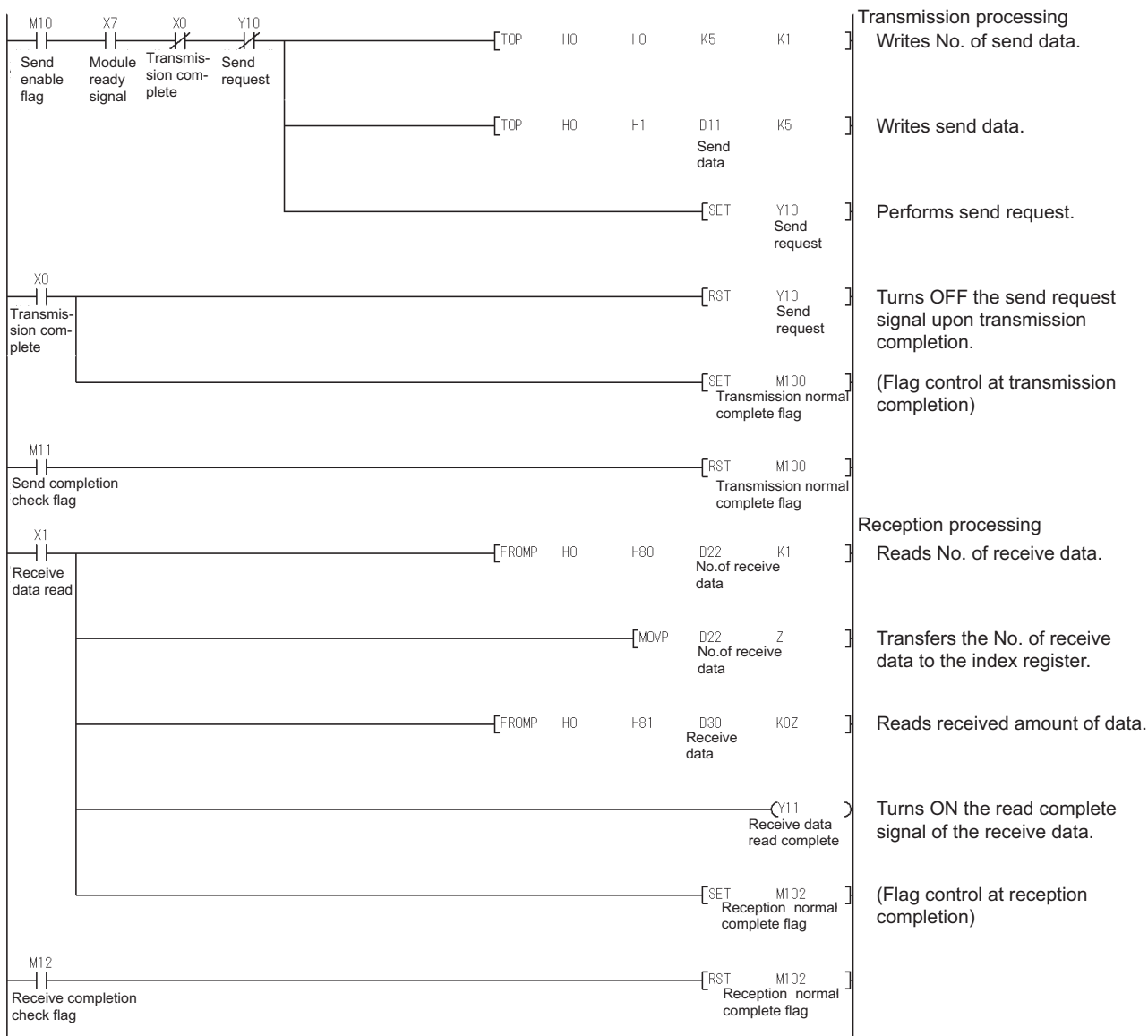

(b) When using dedicated instruction (PRN/INPUT)

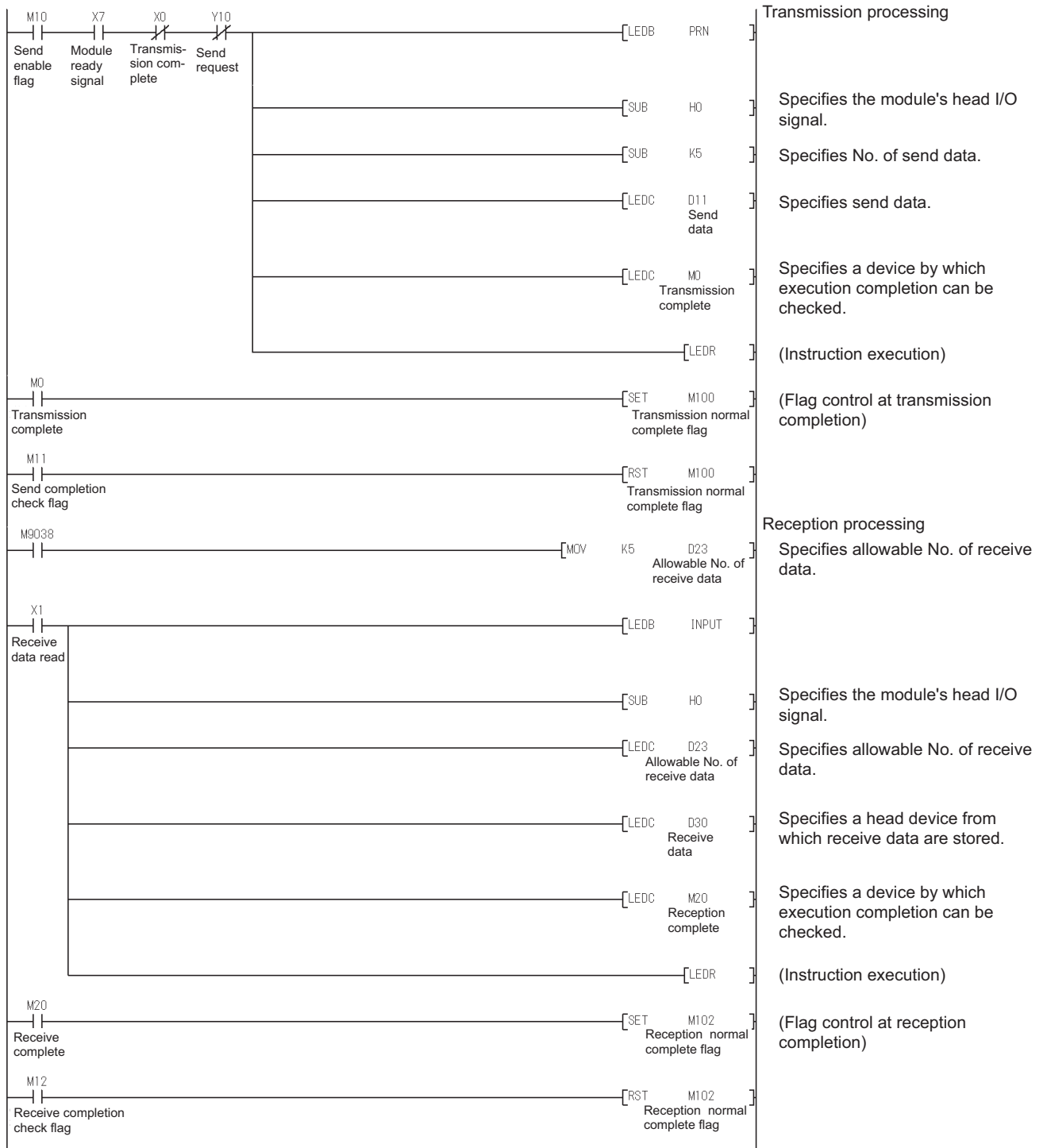

(2) Example of program for Q series serial communication module

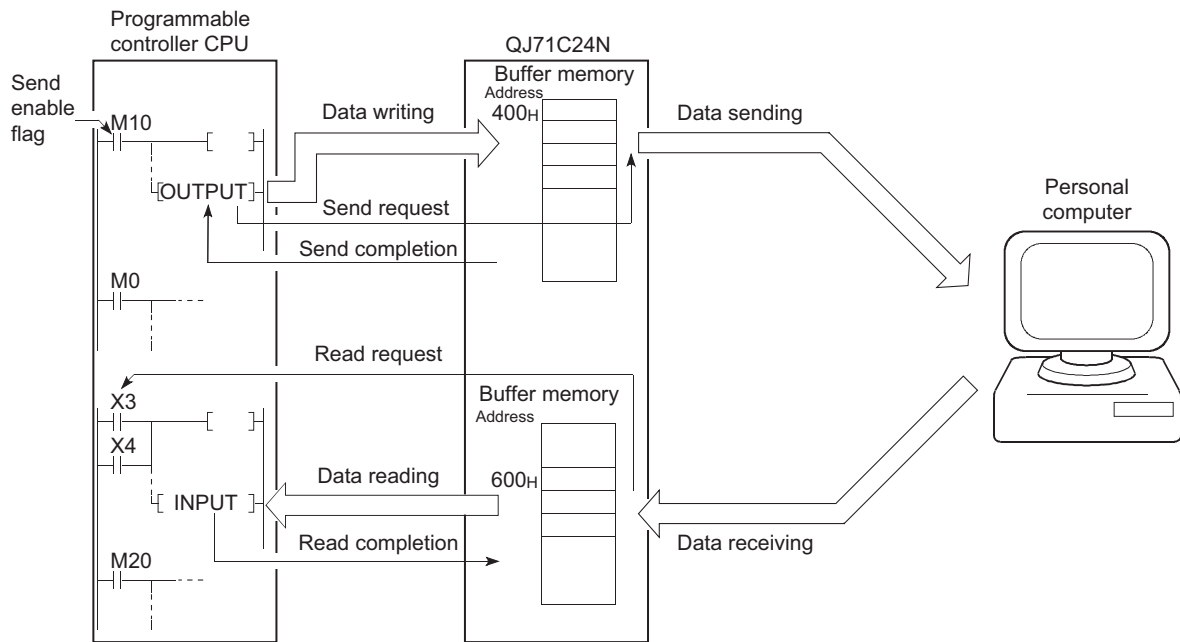

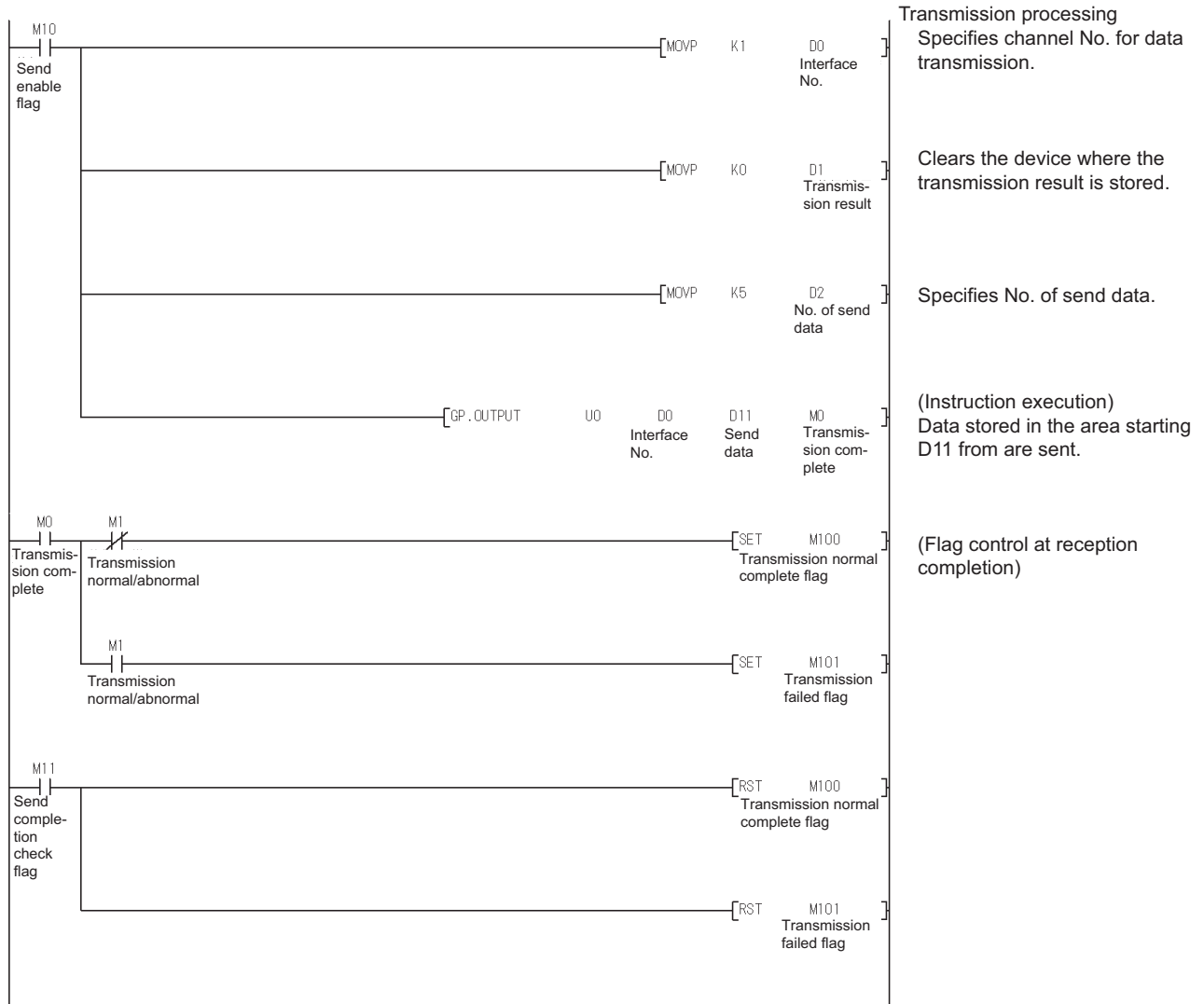

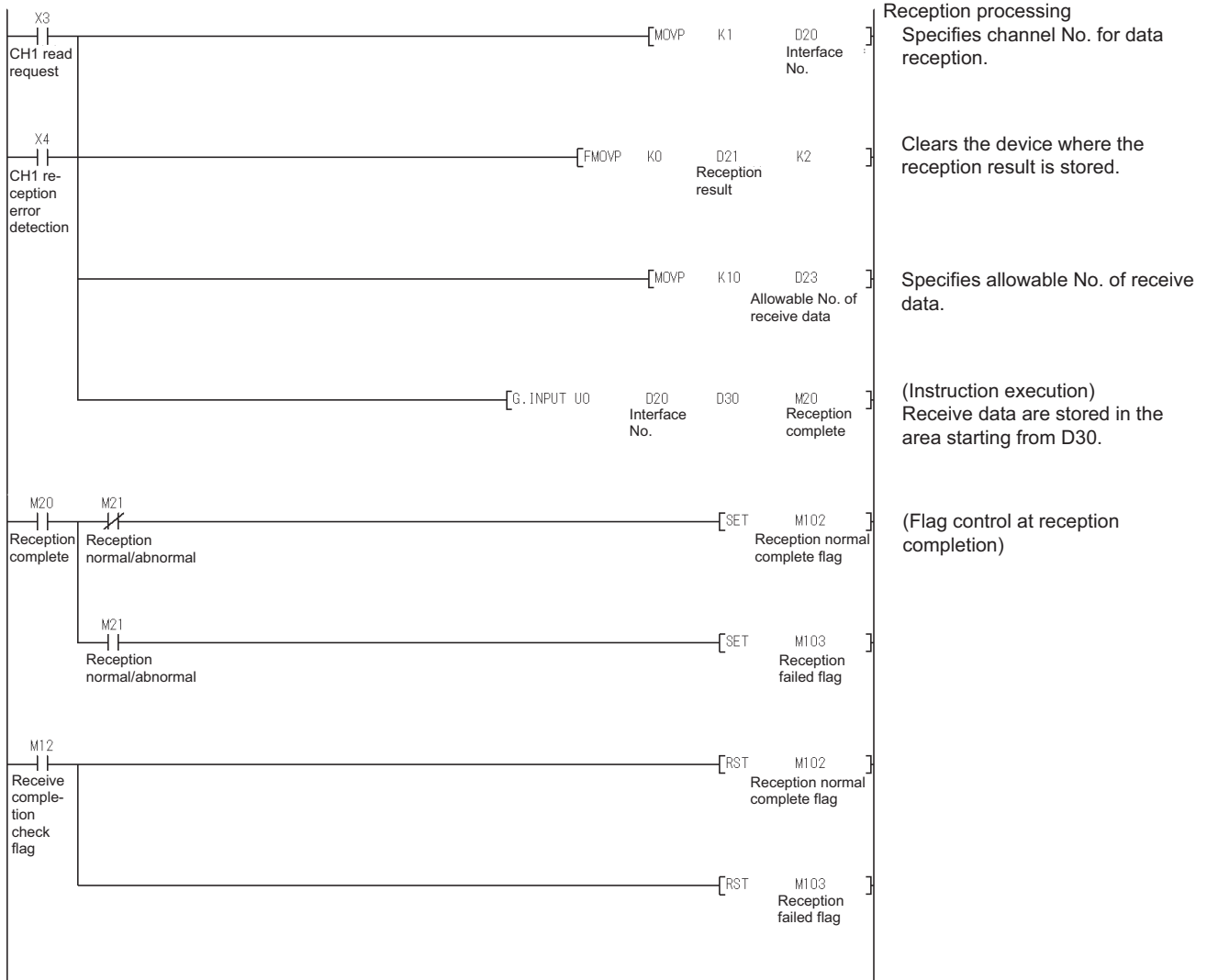

3 ETHERNET INTERFACE MODULE REPLACEMENT

3.1 List of Ethernet Interface Modules to be Replaced

(1) Transition from A series to Q series

Network type	A series	Alternative model
10BASE-T	AJ71E71N3-T	QJ71E71-100
10BASE5	AJ71E71N-B5	QJ71E71-B5* ¹
10BASE2	AJ71E71N-B2	QJ71E71-B2* ¹

(2) Transition from AnS series to Q series

Network type	AnS series	Alternative model
10BASE-T	A1SJ71E71N3-T	QJ71E71-100
10BASE5	A1SJ71E71N-B5	QJ71E71-B5* ¹
10BASE2	A1SJ71E71N-B2	QJ71E71-B2* ¹

(3) Transition from QnA series to Q series

Network type	QnA series	Alternative model
10BASE-T	AJ71QE71N3-T	QJ71E71-100
10BASE5	AJ71QE71N-B5	QJ71E71-B5* ¹
10BASE2	AJ71QE71N-B2	QJ71E71-B2* ¹

(4) Transition from QnAS series to Q series

Network type	QnAS series	Alternative model
10BASE-T	A1SJ71QE71N3-T	QJ71E71-100
10BASE5	A1SJ71QE71N-B5	QJ71E71-B5* ¹
10BASE2	A1SJ71QE71N-B2	QJ71E71-B2* ¹

*1 Production of the QJ71E71-B5 and QJ71E71-B2 will be discontinued on February 28, 2017. For details on the production discontinuation, refer to the TECHNICAL BULLETIN (FA-A-0190).

3.2 Performance Specifications Comparison

3.2.1 Module performance comparison

(1) Comparison between A/AnS series and Q series

(a) 10BASE-T

○: Compatible, △: Partial change required, ×: Incompatible

Item	Specifications			Compat- ibility	Precautions for replacement	
	A series	AnS series	Q series			
	AJ71E71N3-T	A1SJ71E71N3-T	QJ71E71-100			
Transmission specifications	Transmission speed	10Mbps		○		
	Communication mode	Half-duplex		○		
	Transmission method	Base band			○	
	Maximum segment length	100m*1			○	
	Maximum number of nodes/connection	Cascade connection: Up to 4			○	Up to two modules can be connected in a cascade connection when using at 100 Mbps.
Transfer data storage memory	Number of allowable simultaneously open connections	8 connections	16 connections	○		
	Fixed buffer	1k word × 8	1k word × 16	△	Change the sequence program as buffer memory assignments differ. (Refer to Section 3.6.2.)	
	Random access buffer	3k words × 2	6k words × 1	△		
No. of occupied I/O points	32 points/slot (I/O assignment special 32 points)		32 points/slot (I/O assignment intelli 32 points)	○		

*1 Length between hub and node

(b) 10BASE5

○: Compatible, △: Partial change required, ×: Incompatible

Item	Specifications			Compat- ibility	Precautions for replacement	
	A series	AnS series	Q series			
	AJ71E71N-B5	A1SJ71E71N-B5	QJ71E71-B5			
Transmission specifications	Transmission speed	10Mbps			○	
	Communication mode	Half-duplex			○	
	Transmission method	Base band			○	
	Max. distance between nodes	2500m			○	
	Maximum segment length	500m			○	
	Maximum number of nodes/connection	100/segment			○	
	Minimum node interval	2.5m			○	
Transfer data storage memory	Number of allowable simultaneously open connections	8 connections	16 connections	○		
	Fixed buffer	1k word × 8	1k word × 16	△	Change the sequence program as buffer memory assignments differ. (Refer to Section 3.6.2.)	
	Random access buffer	3k words × 2	6k words × 1	△		
No. of occupied I/O points	32 points/slot (I/O assignment special 32 points)		32 points/slot (I/O assignment intelli 32 points)	○		
12V DC external power supply capacity (Transceiver)	Use a transceiver and AUI cables that satisfy specifications.			○		

(c) 10BASE2

○: Compatible, △: Partial change required, ×: Incompatible

Item	Specifications			Compat- ibility	Precautions for replacement
	A series	AnS series	Q series		
	AJ71E71N-B2	A1SJ71E71N-B2	QJ71E71-B2		
Transmission specifications	Transmission speed	10Mbps		○	
	Communication mode	Half-duplex		○	
	Transmission method	Base band		○	
	Max. distance between nodes	925m		○	
	Maximum segment length	185m		○	
	Maximum number of nodes/connection	30/segment		○	
	Minimum node interval	0.5m		○	
Transfer data storage memory	Number of allowable simultaneously open connections	8 connections	16 connections	○	
	Fixed buffer	1k word × 8	1k word × 16	△	Change the sequence program as buffer memory assignments differ. (Refer to Section 3.6.2.)
	Random access buffer	3k words × 2	6k words × 1	△	
No. of occupied I/O points	32 points/slot (I/O assignment special 32 points)	32 points/slot (I/O assignment intelli 32 points)		○	

(2) Comparison between QnA/QnAS series and Q series

(a) 10BASE-T

○: Compatible, △: Partial change required, ×: Incompatible

Item	Specifications			Compat- ibility	Precautions for replacement	
	QnA series	QnAS series	Q series			
	AJ71QE71N3-T	A1S71QE71N3-T	QJ71E71-100			
Transmission specifications	Transmission speed	10Mbps		○		
	Communication mode	Half-duplex		○		
	Transmission method	Base band			○	
	Maximum segment length	100m*1			○	
	Maximum number of nodes/connection	Cascade connection: Up to 4			○	Up to two modules can be connected in a cascade connection when using at 100 Mbps.
Transfer data storage memory	Number of allowable simultaneously open connections	8 connections		○		
	Fixed buffer	1k word × 8		○		
	Random access buffer	6k words × 1			○	
No. of E ² PROM writes	Max. 100,000 times on same area in E ² PROM		-	△	No E ² PROM (Refer to Section 3.8.)	
No. of occupied I/O points	32 points/slot (I/O assignment special 32 points)		32 points/slot (I/O assignment intelli 32 points)	○		

*1 Length between hub and node

(b) 10BASE5

○: Compatible, △: Partial change required, ×: Incompatible

Item	Specifications			Compat- ibility	Precautions for replacement	
	QnA series	QnAS series	Q series			
	AJ71QE71N-B5	A1S71QE71N-B5	QJ71E71-B5			
Transmission specifications	Transmission speed	10Mbps		○		
	Communication mode	Half-duplex		○		
	Transmission method	Base band			○	
	Max. distance between nodes	2500m			○	
	Maximum segment length	500m			○	
	Maximum number of nodes/connection	100/segment			○	
	Minimum node interval	2.5m			○	
Transfer data storage memory	Number of allowable simultaneously open connections	8 connections		○		
	Fixed buffer	1k word × 8		○		
	Random access buffer	6k words × 1			○	
No. of E ² PROM writes	Max. 100,000 times on same area in E ² PROM		-	△	No E ² PROM (Refer to Section 3.8.)	
No. of occupied I/O points	32 points/slot (I/O assignment special 32 points)		32 points/slot (I/O assignment intelli 32 points)	○		
12V DC external power supply capacity (Transceiver)	Use a transceiver and AUI cables that satisfy specifications.			○		

(c) 10BASE2

○: compatible, △: partial change required, ×: Incompatible

Item	Specifications			Compat- ibility	Precautions for replacement
	QnA series	QnAS series	Q series		
	AJ71QE71N-B2	A1S71QE71N-B2	QJ71E71-B2		
Transmission specifications	Transmission speed	10Mbps		○	
	Communication mode	Half-duplex		○	
	Transmission method	Base band		○	
	Max. distance between nodes	925m		○	
	Maximum segment length	185m		○	
	Maximum number of nodes/connection	30/segment		○	
	Minimum node interval	0.5m		○	
Transfer data storage memory	Number of allowable simultaneously open connections	8 connections	16 connections	○	
	Fixed buffer	1k word × 8	1k word × 16	○	
	Random access buffer	6k words × 1		○	
No. of E ² PROM writes	Max. 100,000 times on same area in E ² PROM		-	△	No E ² PROM (Refer to Section 3.8.)
No. of occupied I/O points	32 points/slot (I/O assignment special 32 points)		32 points/slot (I/O assignment intelli 32 points)	○	

3.2.2 Cable specifications comparison

The Q series can use connectable devices (e.g. hubs^{*1}, cables, transceivers^{*2 *3}) that are being used on the A/AnS/QnAQnAS series.

For details on connectable devices, refer to the Q Corresponding Ethernet Interface Module User's Manual (Basic).

- *1 When connecting a hub that does not have the auto-negotiation function
On a connection with a hub that does not have the auto-negotiation function, set the hub side to the half-duplex communication mode.
- *2 About wiring of the external power supply terminal (for the transceiver) on the QJ71E71-B5
An FG terminal is not provided for the external power supply terminal on the QJ71E71-B5.
When handling the FG terminal on the external power supply (for the transceiver), ground the FG signal on the external power supply side.
- *3 The shape of the external power supply terminal (for the transceiver) differs between the QnA series QJ71QE71N-B5 and the Q series QJ71E71-B5. When replacing the AJ71QE71N-B5 with the Q series QJ71E71-B5, refer to the following manual for wiring.
Q Corresponding Ethernet Interface Module User's Manual (Basic)

3.3 Function Comparison

(1) Comparison between A/AnS series and Q series

○: Compatible, △: Partial change required, ×: Incompatible

Item	Description			Compat- ibility	Precautions for replacement
	A series	AnS series	Q series		
	AJ71E71N3-T AJ71E71N-B5 AJ71E71N-B2	A1SJ71E71N3-T A1SJ71E71N-B5 A1SJ71E71N-B2	QJ71E71-100 QJ71E71-B5 QJ71E71-B2		
Initial processing	The state in which data communications with an external device is possible is set.			△	Set in the GX Developer network parameters. ^{*1} (Delete the sequence program of the section corresponding to the function.) (Refer to Section 3.9.)
Open processing	The communications line for performing data communications with external devices is connected.			△	Change to a sequence program that uses the dedicated instructions (OPEN, CLOSE). ^{*5} (Refer to Section 3.9.)
Communications using fixed buffer (procedural, nonprocedural)	The fixed buffer on the Ethernet interface module is used to send/receive the desired data between the programmable controller CPU and external devices.			△	Change to a sequence program that uses the dedicated instructions (BUFSND, BUFRVCV). (Refer to Section 3.9.)
Communications using random access buffer	Data is read/written to the random access buffer of the Ethernet interface module from multiple external devices.			△	Change the sequence program as buffer memory assignments differ. (Refer to Section 3.6.2.)
Read/write communications of programmable controller CPU internal data	Programmable controller CPU data is read/written to and from external devices.			△	Some of the commands and device ranges are restricted. (Refer to Section 3.7.)
Broadcast communication	Data is sent/received to all external devices on the same Ethernet network as the Ethernet interface module by UDP/IP-based data communications. (broadcast)			○	
Communications while the programmable controller CPU is stopped	Data communications can be continued when the programmable controller CPU enters a stop state. (during passive open processing)			△	Set in the GX Developer network parameters. ^{*2} (Delete the sequence program of the section corresponding to the function.)
Router relay function	Data communications is performed via a router and a gateway.			△	Delete the sequence program of the section corresponding to the function, and set in the GX Developer network parameters. ^{*3} Set in the GX Developer network parameters. ^{*3} (Delete the sequence program of the section corresponding to the function.)
Existence check of external device	Whether or not the external device is operating normally after the connection is established (in open processing) is checked.			△	Change to a sequence program that uses the dedicated instructions (OPEN). ^{*5}
Communications using pairing open	The connection is opened with connection for reception and connection for transmission as a single pair. (for fixed buffer communications)			△	Change to a sequence program that uses the dedicated instructions (OPEN). ^{*4*5}
Unit of timer set values for data communications	Set the unit (500 ms/2 s) of timer values	Fixed to 500 ms		△	Set in the GX Developer network parameters. (Delete the sequence program of the section corresponding to the function.) The unit of timer set values is 500 ms.

*1 Initial Processing

The Q series performs initial processing by setting the following items in the GX Developer network parameters.

- "Network parameters Setting the number of Ethernet/CC IE/MELSECNET cards"
- "Operational settings"
- "Initial settings"

There is no need for a sequence program for initial processing/end processing.

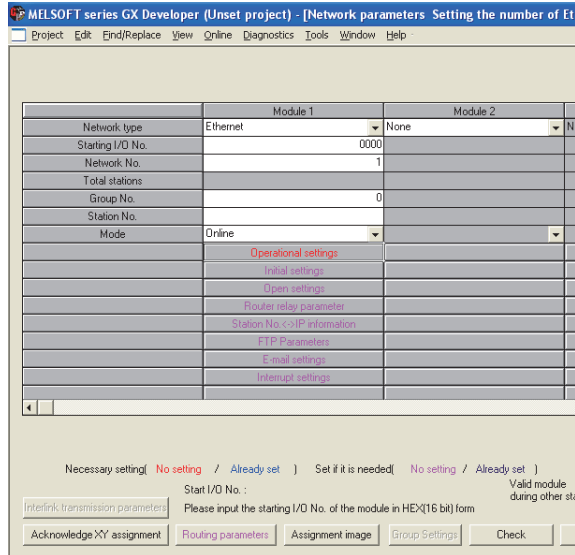

*2 Communications while the programmable controller CPU is stopped

By setting "Operational settings" - "Initial timing" to "Always wait for OPEN", the Q series can perform communications while the programmable controller CPU is stopped.

For connections for which passive open and communications during a stop are set to enabled, it is not necessary to use a sequence program for communications during a stop/open processing/close processing.

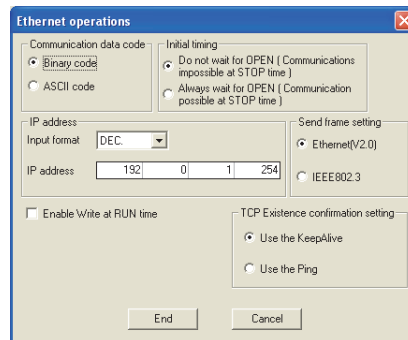

*3 Router relay function

The Q series sets the router relay function at "Network parameters" - "router relay parameter" on GX Developer.

There is no need for a sequence program for the router relay function.

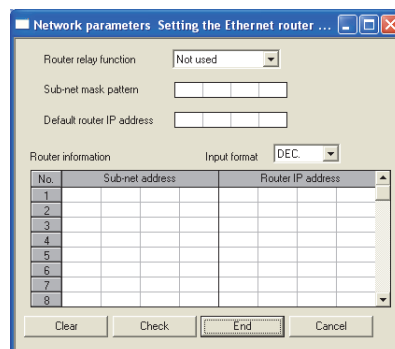

- *4 Communications using pairing open
 - On the Q series, the pairing open setting of connection No.8 is not possible.
(Connection No.8 is pairing for reception, and connection No.1 is pairing for transmission.)
When the pairing open setting of connection No.8 has been made, change the sequence program.
 - On the Q series, the pairing open settings of connection No.1 to 7, and 9 to 15 are possible.
- *5 Open processing
 - When "Operational settings" - "Initial timing" in GX Developer is set to "Always wait for OPEN", the sequence program using dedicated instruction (OPEN/CLOSE) is not required.

(2) Comparison between QnA/QnAS series and Q series

○: Compatible, △: Partial change required, ×: Incompatible

Item		Description			Compat- ibility	Precautions for replacement
		QnA series	QnAS series	Q series		
		AJ71QE71N3-T AJ71QE71N-B5 AJ71QE71N-B2	A1SJ71QE71N3-T A1SJ71QE71N-B5 A1SJ71QE71N-B2	QJ71E71-100 QJ71E71-B5 QJ71E71-B2		
Initial processing	Sequence program	The state in which data communications with an external device is possible is set.			△	Some communications are restricted. ^{*1}
	GX Developer network parameters				○	
Open processing		The communications line for performing data communications with external devices is connected.			○	
Communications using fixed buffer (procedural, nonprocedural)		The fixed buffer on the Ethernet interface module is used to send/receive the desired data between the programmable controller CPU and external devices.			○	
Communications using random access buffer		Data is read/written to the random access buffer of the Ethernet interface module from multiple external devices.			○	
Read/write communications of programmable controller CPU internal data		Programmable controller CPU data is read/written to and from external devices.			△	Some of the commands and device ranges are restricted. (Refer to Section 3.7.)
Communications using data link instructions		Use data link instructions to read/write programmable controller CPU data of other stations via Ethernet.			○	
File transfer (FTP server functions)		Use FTP commands to read/write individual files from external devices.			△	The default log-in name and password have been changed from "AJ71QE71" to "QJ71E71", so set the log-in name again.
Broadcast communication		Data is sent/received to all external devices on the same Ethernet network as the Ethernet interface module by UDP/IP-based data communications. (broadcast)			○	
Communications while the programmable controller CPU is stopped		Data communications can be continued when the programmable controller CPU enters a stop state. (during passive open processing)			△	Delete the sequence program of the section corresponding to the function, and set in the GX Developer network parameters. ^{*2}
MELSECNET/H, MELSECNET/10 relay exchange		On a network system comprising a mixture of Ethernet and MELSECNET/H or MELSECNET/10, or a network system that relays through multiple Ethernets, data communications is performed via these multiple networks.			△	Some communications are restricted. ^{*3}
Router relay function		Data communications is performed via a router and a gateway.			○	
Existence check of external device		Whether or not the external device is operating normally after the connection is established (in open processing) is checked.			○	
Communications using pairing open		The connection is opened with connection for reception and connection for transmission as a single pair. (For fixed buffer communications)			△	Some communications are restricted. ^{*4}
Parameter registration to E ² PROM		Saves parameters to E ² PROM.	-		△	No E ² PROM (Refer to Section 3.8.)

*1 Initial processing using a sequence program

- All of the items (e.g. data code setting) that were set on the QnA series exchange condition setting switch operate in an OFF state.
To change the communication conditions, add the sequence program for re-initial processing.
- As the network number and station number cannot be set, the Ethernet interface module cannot be connected with MELSOFT products (e.g. GX Developer).

To perform the above, perform initial processing by GX Developer network parameters.

- *2 Communications while the programmable controller CPU is stopped
By setting "Operational settings" - "Initial timing" to "Always wait for OPEN", the Q series can perform communications while the programmable controller CPU is stopped.
For connections for which passive open and communications during a stop are set to enabled, it is not necessary to use a sequence program for communications during a stop/open processing/close processing.

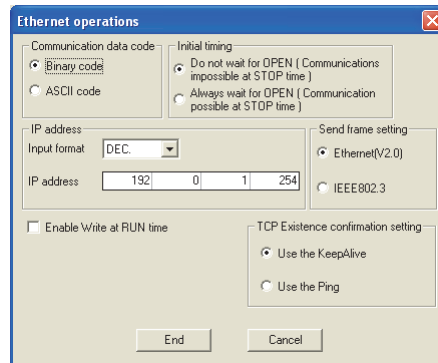

- *3 MELSECNET/H, MELSECNET/10 relay exchange
On the Q series, Ethernet parameters (network number and station number) using the EPRSET instruction cannot be set. When the EPRSET instruction is in use, delete the sequence program of the corresponding section, and set the Ethernet parameters in the GX Developer network parameters.
- *4 Communications using pairing open
On the Q series, the pairing open setting of connection No.8 is not possible.
(Connection No.8 is pairing for reception, and connection No.1 is pairing for transmission.)
When the pairing open setting of connection No.8 has been made, change the sequence program.
On the Q series, the pairing open settings of connection No.1 to 7, and 9 to 15 are possible.

3.4 Switch Setting Comparison

(1) Comparison between A/AnS series and Q series

○: Compatible, △: Partial change required, ×: Incompatible

Switch name		Description			Compat-ibility	Precautions for replacement
		A series	AnS series	Q series		
		AJ71E71N3-T AJ71E71N-B5 AJ71E71N-B2	A1SJ71E71N3-T A1SJ71E71N-B5 A1SJ71E71N-B2	QJ71E71-100 QJ71E71-B5 QJ71E71-B2		
Operation mode setting switch		Selects the operation mode. 0: Online 1: Offline 2: Test 1 (self-loopback test) 3: Test 2 (RAM test) 4: Test 3 (ROM test)			-	△ Set in GX Developer network parameters. (1) in *1
Exchange condition setting switch	SW1	Selection of line processing at a TCP timeout error	Selects line processing when a TCP ULP timeout error occurs. OFF: Closes the line ON: Does not close the line		-	△ Closes the line when a TCP ULP timeout error occurs.
	SW2	Data code setting	Selects the communications data code type. OFF: Binary code ON: ASCII code		-	△ Set in GX Developer network parameters. (2) in *1
	SW7	CPU communications timing setting	Selects write during RUN enable/disable. OFF: Write during RUN disabled ON: Write during RUN enabled		-	△ Set in GX Developer network parameters. (3) in *1
	SW8	Initial timing	Selects the initial processing startup timing. OFF: Quick start ON: Normal start		-	△ A quick start is performed (Initial processing starts up with no delay time.)

*1 GX Developer network parameters

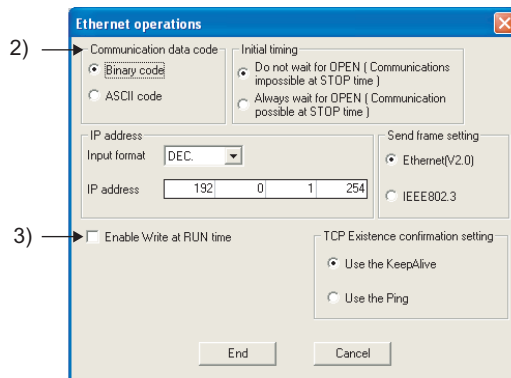
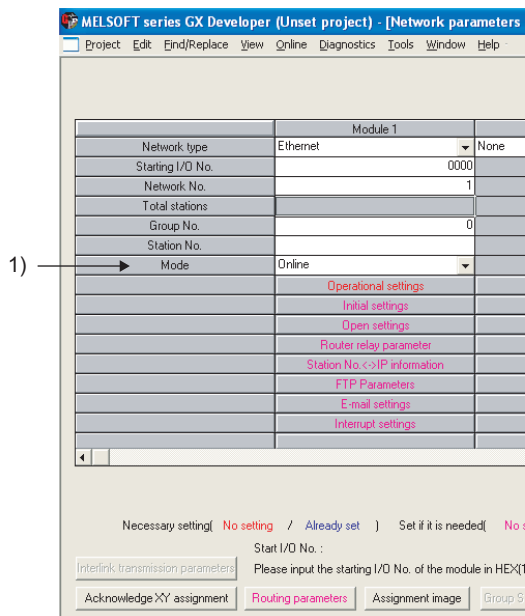

(2) Comparison between QnA/QnAS series and Q series

○: Compatible, △: Partial change required, ×: Incompatible

Switch name	Description			Compat- ibility	Precautions for replacement	
	QnA series	QnAS series	Q series			
	AJ71QE71N3-T AJ71QE71N-B5 AJ71QE71N-B2	A1SJ71QE71N3-T A1SJ71QE71N-B5 A1SJ71QE71N-B2	QJ71E71-100 QJ71E71-B5 QJ71E71-B2			
Operation mode setting switch		Selects the operation mode. 0: Online 1: Offline 2: Test 1 (self-loopback test) 3: Test 2 (RAM test) 4: Test 3 (ROM test) 5: Test 4 (E ² PROM test)	-	△	Set in GX Developer network parameters. (1) in *1)	
Exchange condition setting switch	SW1	Selection of line processing at a TCP timeout error	Selects line processing when a TCP ULP timeout error occurs. OFF: Closes the line ON: Does not close the line	-	△	Closes the line when a TCP ULP timeout error occurs.
	SW2	Data code setting	Selects the communications data code type. OFF: Binary code ON: ASCII code	-	△	Set in GX Developer network parameters. (2) in *1)
	SW3	Automatic startup mode setting	Selects the startup method when a module is started. OFF: Operation follows Y19 ON: Operation regardless of Y19	-	△	Operation follows the setting of Y19.*2
	SW7	CPU communications timing setting	Selects write during RUN enable/disable. OFF: Write during RUN disabled ON: Write during RUN enabled	-	△	Set in GX Developer network parameters. (3) in *1)
	SW8	Initial timing	Selects the initial processing startup timing. OFF: Quick start ON: Normal start	-	△	A quick start is performed (Initial processing starts up with no delay time.)

*1 GX Developer network parameters

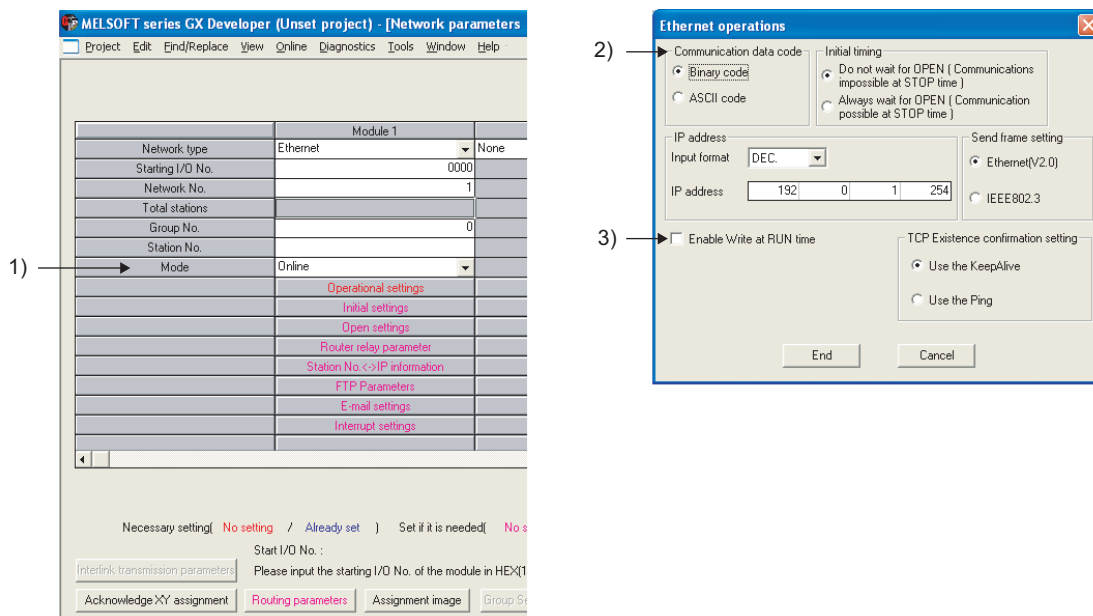

*2 When performing initial processing using GX Developer network parameters, initial processing is executed automatically. (There is no need for a sequence program for initial processing/end processing.)

3.5 Parameter Comparison

(1) Comparison between A/AnS series and Q series

On the A/AnS series, the parameters of the Ethernet interface module are set in the buffer memory. On the Q series, however, the parameters are set using GX Developer network parameters. Therefore, there is no compatibility between the parameters of the A/AnS series and the Q series. When replacing the A/AnS series with the Q series, delete the parameter settings of the A/AnS series and set new parameters on GX Developer.

(2) Comparison between QnA/QnAS series and Q series

○: Compatible, △: Partial change required, ×: Incompatible

Parameter name	Description			Compat- ibility	Precautions for replacement
	QnA series	QnAS series	Q series		
	AJ71QE71N3-T AJ71QE71N-B5 AJ71QE71N-B2	A1SJ71QE71N3-T A1SJ71QE71N-B5 A1SJ71QE71N-B2	QJ71E71-100 QJ71E71-B5 QJ71E71-B2		
Network parameter	Network type			○	
	Start I/O No.			○	
	Network No.			○	
	Group No.			○	
	Station No.			○	
	-		Mode	△	On the QnA series, the mode was set on the operation mode setting switch.
	IP address setting		Operational setting	○	
	-		Initial settings	△	On the QnA series, the setting was set in the sequence program.
	-		Open settings	△	
	Station No. <-> IP information			○	
	FTP Parameters			○	
	Router relay parameter			○	
	Routing parameters			○	

3.6 Program Comparison

3.6.1 I/O signal

(1) Comparison between A/AnS series and Q series

○: Compatible, △: Partial change required, ×: Incompatible

Input signal	Signal name			Compat- ibility	Precautions for replacement
	A series	AnS series	Q series		
	AJ71E71N3-T AJ71E71N-B5 AJ71E71N-B2	A1SJ71E71N3-T A1SJ71E71N-B5 A1SJ71E71N-B2	QJ71E71-100 QJ71E71-B5 QJ71E71-B2		
Xn0	Transmission normal end or reception end (For connection No.1)			○	
Xn1	Transmission error detection or reception error detection (For connection No.1)			○	
Xn2	Transmission normal end or reception end (For connection No.2)			○	
Xn3	Transmission error detection or reception error detection (For connection No.2)			○	
Xn4	Transmission normal end or reception end (For connection No.3)			○	
Xn5	Transmission error detection or reception error detection (For connection No.3)			○	
Xn6	Transmission normal end or reception end (For connection No.4)			○	
Xn7	Transmission error detection or reception error detection (For connection No.4)			○	
Xn8	Transmission normal end or reception end (For connection No.5)			○	
Xn9	Transmission error detection or reception error detection (For connection No.5)			○	
XnA	Transmission normal end or reception end (For connection No.6)			○	
XnB	Transmission error detection or reception error detection (For connection No.6)			○	
XnC	Transmission normal end or reception end (For connection No.7)			○	
XnD	Transmission error detection or reception error detection (For connection No.7)			○	
XnE	Transmission normal end or reception end (For connection No.8)			○	
XnF	Transmission error detection or reception error detection (For connection No.8)			○	
X(n+1)0	Open end (For connection No.1)			○	
X(n+1)1	Open end (For connection No.2)			○	
X(n+1)2	Open end (For connection No.3)			○	
X(n+1)3	Open end (For connection No.4)			○	
X(n+1)4	Open end (For connection No.5)			○	
X(n+1)5	Open end (For connection No.6)			○	
X(n+1)6	Open end (For connection No.7)			○	
X(n+1)7	Open end (For connection No.8)			○	
X(n+1)8	Open error detection			○	
X(n+1)9	Initial normal end			○	
X(n+1)A	Initial error end			○	
X(n+1)B	Use prohibited			○	
X(n+1)C	COM. ERR LED ON			○	
X(n+1)D	Use prohibited			○	
X(n+1)E					
X(n+1)F	Watchdog timer error detection			○	

○: Compatible, △: Partial change required, ×: Incompatible

Output signal	Signal name			Compat- ibility	Precautions for replacement
	A series	AnS series	Q series		
	AJ71E71N3-T AJ71E71N-B5 AJ71E71N-B2	A1SJ71E71N3-T A1SJ71E71N-B5 A1SJ71E71N-B2	QJ71E71-100 QJ71E71-B5 QJ71E71-B2		
Yn0	Transmission request or reception end check (For connection No.1)			○	
Yn1	Transmission request or reception end check (For connection No.2)			○	
Yn2	Transmission request or reception end check (For connection No.3)			○	
Yn3	Transmission request or reception end check (For connection No.4)			○	
Yn4	Transmission request or reception end check (For connection No.5)			○	
Yn5	Transmission request or reception end check (For connection No.6)			○	
Yn6	Transmission request or reception end check (For connection No.7)			○	
Yn7	Transmission request or reception end check (For connection No.8)			○	
Yn8	Open request (For connection No.1)			○	
Yn9	Open request (For connection No.2)			○	
YnA	Open request (For connection No.3)			○	
YnB	Open request (For connection No.4)			○	
YnC	Open request (For connection No.5)			○	
YnD	Open request (For connection No.6)			○	
YnE	Open request (For connection No.7)			○	
YnF	Open request (For connection No.8)			○	
Y(n+1)0	Use prohibited			○	
Y(n+1)1					
Y(n+1)2					
Y(n+1)3					
Y(n+1)4					
Y(n+1)5					
Y(n+1)6					
Y(n+1)7	COM. ERR LED OFF request			○	
Y(n+1)8	Use prohibited			○	
Y(n+1)9	Initial request			○	
Y(n+1)A	Use prohibited			○	
Y(n+1)B					
Y(n+1)C	Buffer memory channel switching	-		△	Buffer memory channel setting is not required. Delete the sequence program of the section corresponding to the function.
Y(n+1)D	Use prohibited			○	
Y(n+1)E					
Y(n+1)F					

(2) Comparison between QnA/QnAS series and Q series

○: compatible, △: partial change required, ×: Incompatible

Input signal	Signal name			Compat- ibility	Precautions for replacement
	QnA series	QnAS series	Q series		
	AJ71QE71N3-T AJ71QE71N-B5 AJ71QE71N-B2	A1SJ71QE71N3-T A1SJ71QE71N-B5 A1SJ71QE71N-B2	QJ71E71-100 QJ71E71-B5 QJ71E71-B2		
Xn0	Transmission normal end or reception end (For connection No.1)			○	
Xn1	Transmission error detection or reception error detection (For connection No.1)			○	
Xn2	Transmission normal end or reception end (For connection No.2)			○	
Xn3	Transmission error detection or reception error detection (For connection No.2)			○	
Xn4	Transmission normal end or reception end (For connection No.3)			○	
Xn5	Transmission error detection or reception error detection (For connection No.3)			○	
Xn6	Transmission normal end or reception end (For connection No.4)			○	
Xn7	Transmission error detection or reception error detection (For connection No.4)			○	
Xn8	Transmission normal end or reception end (For connection No.5)			○	
Xn9	Transmission error detection or reception error detection (For connection No.5)			○	
XnA	Transmission normal end or reception end (For connection No.6)			○	
XnB	Transmission error detection or reception error detection (For connection No.6)			○	
XnC	Transmission normal end or reception end (For connection No.7)			○	
XnD	Transmission error detection or reception error detection (For connection No.7)			○	
XnE	Transmission normal end or reception end (For connection No.8)			○	
XnF	Transmission error detection or reception error detection (For connection No.8)			○	
X(n+1)0	Open end (For connection No.1)			○	
X(n+1)1	Open end (For connection No.2)			○	
X(n+1)2	Open end (For connection No.3)			○	
X(n+1)3	Open end (For connection No.4)			○	
X(n+1)4	Open end (For connection No.5)			○	
X(n+1)5	Open end (For connection No.6)			○	
X(n+1)6	Open end (For connection No.7)			○	
X(n+1)7	Open end (For connection No.8)			○	
X(n+1)8	Open error detection			○	
X(n+1)9	Initial normal end			○	
X(n+1)A	Initial error end			○	
X(n+1)B	Use prohibited			○	
X(n+1)C	COM. ERR LED ON			○	
X(n+1)D	E ² PROM read complete	Use prohibited		△	No E ² PROM (Refer to Section 3.8.)
X(n+1)E	E ² PROM write complete			△	
X(n+1)F	Watchdog timer error detection			○	

○: compatible, △: partial change required, ×: Incompatible

Output signal	Signal name			Compat- ibility	Precautions for replacement
	QnA series	QnAS series	Q series		
	AJ71QE71N3-T AJ71QE71N-B5 AJ71QE71N-B2	A1S71QE71N3-T A1S71QE71N-B5 A1S71QE71N-B2	QJ71E71-100 QJ71E71-B5 QJ71E71-B2		
Yn0	Transmission request or reception end check (For connection No.1)			○	
Yn1	Transmission request or reception end check (For connection No.2)			○	
Yn2	Transmission request or reception end check (For connection No.3)			○	
Yn3	Transmission request or reception end check (For connection No.4)			○	
Yn4	Transmission request or reception end check (For connection No.5)			○	
Yn5	Transmission request or reception end check (For connection No.6)			○	
Yn6	Transmission request or reception end check (For connection No.7)			○	
Yn7	Transmission request or reception end check (For connection No.8)			○	
Yn8	Open request (For connection No.1)			○	
Yn9	Open request (For connection No.2)			○	
YnA	Open request (For connection No.3)			○	
YnB	Open request (For connection No.4)			○	
YnC	Open request (For connection No.5)			○	
YnD	Open request (For connection No.6)			○	
YnE	Open request (For connection No.7)			○	
YnF	Open request (For connection No.8)			○	
Y(n+1)0	E ² PROM read request		Use prohibited	△	No E ² PROM (Refer to Section 3.8.)
Y(n+1)1	E ² PROM write request			△	
Y(n+1)2	Use prohibited			○	
Y(n+1)3					
Y(n+1)4					
Y(n+1)5					
Y(n+1)6					
Y(n+1)7	COM. ERR LED OFF request			○	
Y(n+1)8	Use prohibited			○	
Y(n+1)9	Initial request			○	
Y(n+1)A	Use prohibited			○	
Y(n+1)B					
Y(n+1)C					
Y(n+1)D					
Y(n+1)E					
Y(n+1)F					

3.6.2 Buffer memory

(1) Comparison between A/AnS series and Q series

There is no compatibility in the buffer memory assignments between the A/AnS series and the Q series. Make a new sequence program.

○: Compatible, △: Partial change required, ×: Incompatible

Buffer memory address		Buffer memory name		Compat- ibility	Precautions for replacement
HEX	DEC	A series	AnS series		
		AJ71E71N3-T AJ71E71N-B5 AJ71E71N-B2	A1SJ71E71N3-T A1SJ71E71N-B5 A1SJ71E71N-B2		
0 to 1 _H	0 to 1	Local station IP address		△	Set in GX Developer network parameters.
2 _H	2	Special function setting		△	
3 _H	3	Timer setting time units		△	Not used on the Q series
4 to 5 _H	4 to 5	System area (Use prohibited)		-	
6 _H	6	TCP Maximum Segment transmission setting		△	1E _H (30) is used on the Q series.
7 _H	7	Destination existence check start interval timer value		△	Set in GX Developer network parameters.
8 _H	8	Destination existence check interval timer value		△	
9 _H	9	Destination existence check, No. of retries		△	
A _H	10	TCP ULP timeout value		△	
B _H	11	TCP zero window timer value		△	
C _H	12	TCP retransmit timer value		△	
D _H	13	TCP end timer value		△	
E _H	14	IP reassembly timer value		△	
F _H	15	Response monitoring timer value		△	
10 to 17 _H	16 to 23	Application setting area (Connection No.1 to 8)		△	
18 to 4F _H	24 to 79	Exchange address settings area (Connection No.1 to 8)		△	
50 _H	80	Initial error code		△	69 _H (105) is used on the Q series.
51 to 52 _H	81 to 82	Local station IP address		△	6A to 6B _H (106 to 107) is used on the Q series.
53 to 55 _H	83 to 85	Local station Ethernet address		△	6C to 6E _H (108 to 110) is used on the Q series.
56 to 58 _H	86 to 88	System area (Use prohibited)		-	
59 to A8 _H	89 to 168	Information for each connection (Connection No.1 to 8)		△	78 to C7 _H (120 to 199) is used on the Q series.
A9 to B3 _H	169 to 179	Error log1 to 11		△	E5 to 174 _H (229 to 372) is used on the Q series.
B4 to 16F _H	180 to 367	System area (Use prohibited)		-	
170 to 1A3 _H	368 to 419	Status information by protocol type		△	178 to 1F1 _H (376 to 497) is used on the Q series.
1A4 to 1BF _H	420 to 447	System area (Use prohibited)		-	
1C0 to 1C1 _H	448 to 449	Subnet mask field		△	Set in GX Developer network parameters.
1C2 to 1C3 _H	450 to 451	Default router IP address		△	
1C4 _H	452	No. of registered routers		△	
1C5 to 1D8 _H	453 to 472	Setting of router 1 to 5		△	
1D9 to 1EF _H	473 to 495	System area (Use prohibited)		-	
1F0 _H	496	Communication specification during STOP		△	Not used on the Q series
1F1 to 1FF _H	497 to 511	System area (Use prohibited)		-	
200 to 11FF _H	512 to 4607	Fixed buffer No.1 to 8		△	680 to 267F _H (1664 to 9855) is used on the Q series.
1200 to 1DFF _H	4608 to 7679	Random access buffer		△	2680 to 3E7F _H (9856 to 15999) is used on the Q series.

(2) Comparison between QnA/QnAS series and Q series

The buffer memory assignment of the QnA/QnAS series is compatible with that of the Q series.
The sequence program of the QnA/QnAS series can be used as is.

○: Compatible, △: Partial change required, ×: Incompatible

Buffer memory address		Buffer memory name			Compat- ibility	Precautions for replacement
HEX	DEC	QnA series	QnAS series	Q series		
		AJ71QE71N3-T AJ71QE71N-B5 AJ71QE71N-B2	A1SJ71QE71N3-T A1SJ71QE71N-B5 A1SJ71QE71N-B2	QJ71E71-100 QJ71E71-B5 QJ71E71-B2		
0 to 1 _H	0 to 1	Local station IP address			○	
2 to 3 _H	2 to 3	System area (Use prohibited)			○	
4 _H	4	Special function setting			○	
5 to A _H	5 to 10	System area (Use prohibited)			○	
B to 13 _H	11 to 19	Monitoring timer			○	
14 _H	20	Automatically open UDP port No.			○	
15 to 1D _H	21 to 29	System area (Use prohibited)			○	
1E _H	30	TCP Maximum Segment transmission setting			○	
1F _H	31	System area (Use prohibited)			○	
20 to 27 _H	32 to 39	Application setting area (Connection No.1 to 8)			○	
28 to 5F _H	40 to 95	Exchange address settings area (Connection No.1 to 8)			○	
60 to 66 _H	96 to 102	System area (Use prohibited)			○	
67 _H	103	Communication specification during STOP		System area (Use prohibited)	△	Delete the sequence program.
68 _H	104	E ² PROM parameter portion specification			△	
69 _H	105	Initial error code			○	
6A to 6B _H	106 to 107	Local station IP address			○	
6C to 6E _H	108 to 110	Local station Ethernet address			○	
6F _H	111	System area			○	
70 _H	112	E ² PROM register status		System area (Use prohibited)	△	Delete the sequence program.
71 _H	113	Parameter use status			△	
72 _H	114	E ² PROM read result			△	
73 _H	115	E ² PROM write result			△	
74 _H	116	Automatically open UDP port No.			○	
75 _H	117	System area (Use prohibited)			○	
76 _H	118	Network No./Station No.			○	
77 _H	119	Group No.			○	
78 to C7 _H	120 to 199	Information for each connection (Connection No.1 to 8)			○	
C8 _H	200	LED ON status (Left side)		LED ON status	△	Check the LED ON status at C8 _H (200).
C9 _H	201	LED ON status (Right side)		Hub connection status area	△	
CA _H	202	Operation mode setting switch status			○	
CB _H	203	Exchange condition setting switch status		GX Developer setting status	△	Stores the setting status of the GX Developer network parameters.
CC _H	204	System area (Use prohibited)			○	
CD _H	205	RECV instruction execution request			○	
CE _H	206	System area (Use prohibited)			○	
CF to DF _H	207 to 223	Data link command execution result by channel			△	Stores the execution result of the ZNRD, ZNWR instructions.
E0 to E2 _H	224 to 226	System area (Use prohibited)			○	
E3 _H	227	No. of errors generated			○	
E4 _H	228	Error log write pointer			○	
E5 to 174 _H	229 to 372	Error log block 1 to 16			○	
175 to 177 _H	373 to 375	System area (Use prohibited)			○	
178 to 1FF _H	376 to 511	Status information by protocol type			△	Some assignments differ. For details, refer to the Q Corresponding Ethernet Interface Module User's Manual (Basic).
200 to 201 _H	512 to 513	Subnet mask field			○	
202 to 203 _H	514 to 515	Default router IP address			○	

○: Compatible, △: Partial change required, ×: Incompatible

Buffer memory address		Buffer memory name			Compat- ibility	Precautions for replacement
HEX	DEC	QnA series	QnAS series	Q series		
		AJ71QE71N3-T AJ71QE71N-B5 AJ71QE71N-B2	A1SJ71QE71N3-T A1SJ71QE71N-B5 A1SJ71QE71N-B2	QJ71E71-100 QJ71E71-B5 QJ71E71-B2		
204 _H	516	No. of registered routers			○	
205 to 224 _H	517 to 548	Setting of router 1 to 8			○	
225 to 227 _H	549 to 551	System area (Use prohibited)			○	
228 _H	552	Number of conversion table data			○	
229 to 3A8 _H	553 to 936	Conversion information No.1 to 64			○	
3A9 to 3AA _H	937 to 938	Net mask pattern for MELSECNET/10 routing			○	
3AB to 3AF _H	939 to 943	System area (Use prohibited)			○	
3B0 to 67F _H	944 to 1663	FTP setting			△	The default log-in name and password have been changed from "AJ71QE71" to "QJ71E71". Set in GX Developer network parameters.
680 to 267F _H	1664 to 9855	Fixed buffer No.1 to 8			○	
2680 to 3E7F _H	9856 to 15999	Random access buffer			○	

3.7 Reuse of Existing Programs

(1) A/AnS series

○: Compatible, △: Partial change required, ×: Incompatible

Item	Compatibility		Precautions for replacement
	Program (Communication target device)	Sequence program (Ethernet Interface module)	
Communications using fixed buffer (procedural, nonprocedural)	○	△	[Programmable controller side] The sequence program is not compatible as buffer memory assignments differ. Change to a sequence program that uses the dedicated instructions (BUFSND/BUFRCV).
Communications using random access buffer	○	△	[Programmable controller side] The sequence program is not compatible as buffer memory assignments differ. Check the buffer memory assignments and change the sequence program.
Read/write of programmable controller CPU internal data	△	-	[Communication target device side] Some of the command and device ranges are restricted.*1

*1 Read/write of programmable controller CPU internal data

(1) On the Q series, some commands (batch read/writer of microcomputer) are not usable.

For details, refer to the MELSEC communication protocol reference manual.

(2) Devices of the same name that exist on the A/AnS series programmable controller CPU can be read/written within the device ranges of AnACPU.

The following devices cannot be accessed from external devices:

- Devices newly added on by Q/QnACPU
- Latch relays (L) and step relays (S)
- In the case of Q/QnACPU, the internal relays (M), the latch relays (L) and step relays (S) of other devices can not be specified as target devices to be accessed.
- File registers (R)

(3) The following devices are accessed on special relays (M9000 onwards) and special registers (D9000 onwards):

- SD1000 to SD1255 are accessed by specifying D9000 to D9255.
- SM1000 to SM1255 are accessed by specifying M9000 to M9255.

(2) QnA/QnAS series

○: Compatible, △: Partial change required, ×: Incompatible

Item	Compatibility		Precautions for replacement
	Program (Communication target device)	Sequence program (Ethernet Interface module)	
Communications using fixed buffer (procedural, nonprocedural)	○	○	
Communications using random access buffer	○	○	
Read/write of programmable controller CPU internal data	△	-	[Communication target device side] Some of the command and device ranges are restricted.*1
Communications using data link instructions	○	○	
File transfer (FTP server functions)	△	-	[Communication target device side] The default log-in name and password have been changed from "AJ71QE71" to "QJ71E71", so set the log-in name again.

*1 Read/write of programmable controller CPU internal data

(1) Commands relating to file operations on QCPU differ from commands for QnACPU.

For details, refer to the MELSEC communication protocol reference manual.

(2) The program for accessing the programmable controller CPU in the data link system cannot be used.

(The QCPU (Q mode) cannot be connected to MELSECNET (II) and MELSECNET/B.)

3.8 Other Precaution

(1) Parameter registration to E²PROM

As the Q series Ethernet interface module does not have an E²PROM, delete the sequence program of the section corresponding to parameter registration to E²PROM.

On the Q series Ethernet interface module, set the GX Developer network parameters to save parameters to the programmable controller CPU.

(2) Initial processing/end processing

Initial processing using GX Developer network parameters cannot be used jointly with initial processing/end processing using the sequence program.

When using GX Developer network parameters, delete processing by the sequence program.

(3) Open processing/close processing

Do not use open processing/close processing using I/O signals with open/close processing using dedicated instructions (OPEN/CLOSE) in the same connection.

(4) Passive open processing

The Q series Ethernet interface module cannot cancel open requests before an open end after passive open processing is executed.

Perform close processing after an open end.

(5) Communications using fixed buffer

Do not use fixed buffer communication using I/O signals and fixed buffer communication using dedicated instructions (BUFSND/BUFRCV/BUFRCVS) in the same connection.

(6) About processing time

The data communications processing time differs on the A/AnS/QnA/QnAS series modules and Q series modules.

For this reason, the data communications timing, etc. also differ. If necessary, adjust the timing by inserting a wait time, for example.

For actual details on processing times, refer to the manual for the respective module.

(7) Replacement of the 10BASE5/10BASE2 with the 100BASE-TX/10BASE-T

The A/AnS/QnA/QnAS series 10BASE5/10BASE2 module can be also replaced with the Q series 100BASE-TX/10BASE-T module. Note that a media converter is required. For details, refer to the following TECHNICAL BULLETIN.

TECHNICAL BULLETIN No. FA-A-0075 "Production discontinuation of the AnS and QnAS series Ethernet interface modules"

3.9 Program Examples

The following shows a program example at transition from the A/AnS series to the Q series. When applying the program example introduced in this section to an actual program, sufficiently study if there will be any problem in control on the target system.

(1) System configuration

The following shows the system configuration used in the program example in this section.

(a) A/AnS series

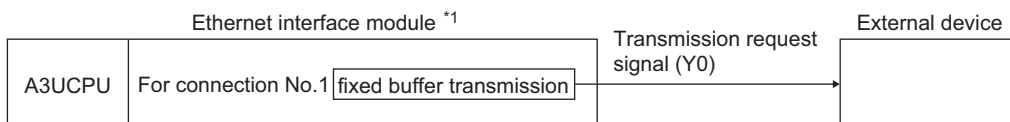

(b) Q series

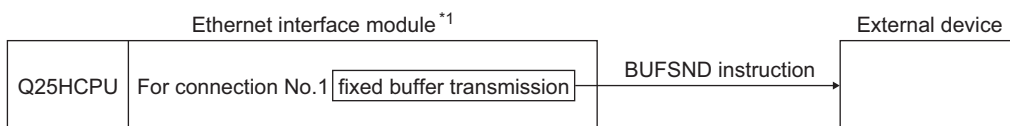

*1 The Ethernet interface module is mounted on slot 0 of the base module.
The I/O signals of the Ethernet interface module shall be X/Y0 to X/YF.

3.9.1 Initial processing

The following shows a program example for performing initial processing.

(1) A/AnS series

The A/AnS series performs initial processing by writing parameters for initial processing by the sequence program to buffer memory and turning the initial request signal (Y19) ON.

(a) Program conditions

The following shows a program example for performing initial processing when the communication start instruction (X40) is turned ON.

Set the parameters for initial processing as follows. (Otherwise, use default values.)

Buffer memory address	Item	Set value
DEC (HEX)		
0 to 1 (0 to 1 _H)	Local station IP address	A20009C0 _H (162.0.9.192)

(b) Program example

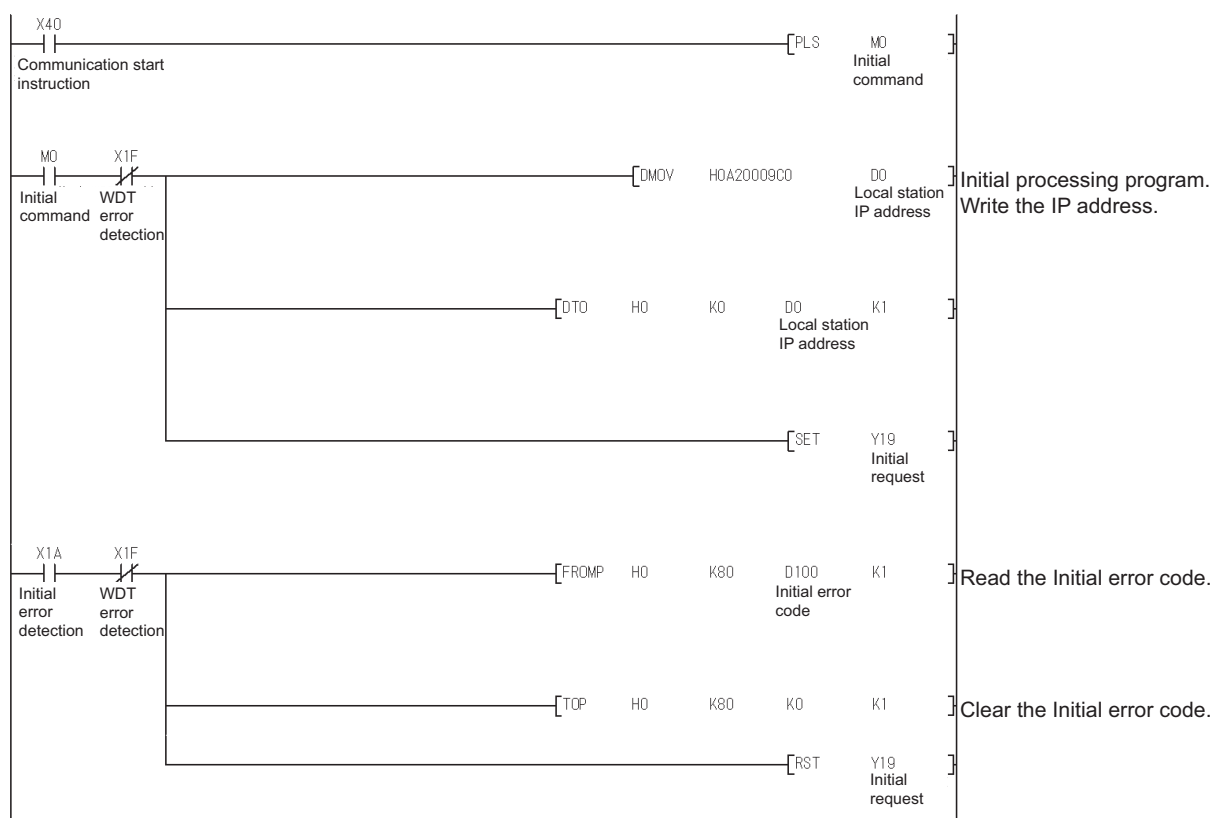

☒ Point

On the Q series, the parameter for initial processing is set using GX Developer network parameters. When replacing the A/AnS series with the Q series, refer to Section 3.9.1 (1) to delete the program where the parameter for initial processing is set and set the parameter using GX Developer network parameters.

(2) Q series

The Q series performs initial processing by setting the following items in the GX Developer network parameters.

- "Network Parameter Setting the Number of Ethernet/CC IE/MELSECNET Cards"
- "Operational settings"
- "Initial settings"

When replacing the A/AnS series with the Q series, delete the A/AnS series' sequence program for initial processing.

(a) Program conditions

Set as follows in the GX Developer network parameters:

- IP address: A20009C0H (162.0.9.192)
- Other than IP address: Use default values.

(b) Network parameter setting example

1) "Network parameters Setting the number of Ethernet/CC IE/MELSECNET cards"

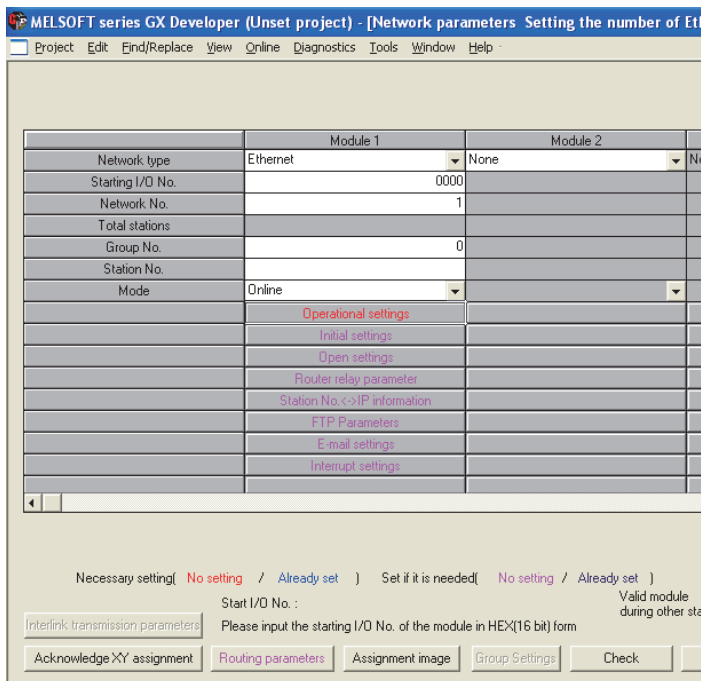

2) "Operational settings"

Ethernet operations

Communication data code:
 Binary code
 ASCII code

Initial timing:
 Do not wait for OPEN (Communications impossible at STOP time)
 Always wait for OPEN (Communication possible at STOP time)

IP address:
 Input format: DEC
 IP address: 162 0 9 192

Send frame setting:
 Ethernet(V2.0)
 IEEE802.3

Enable Write at RUN time

TCP Existence confirmation setting:
 Use the KeepAlive
 Use the Ping

End Cancel

3) "Initial settings"

Network parameter Ethernet initial setting, Module No. 1

Timer setting
 Module will operate with default values if setting is left blank

	Setting value	Default value	In units
TCP ULP timer		60	×500ms
TCP zero window timer		20	×500ms
TCP resend timer		20	×500ms
TCP end timer		40	×500ms
IP assembly timer		10	×500ms
Response monitoring timer		60	×500ms
Destination existence conformation starting interval		1200	
Destination existence conformation interval timer		20	×500ms
Destination existence conformation resend		3	Times

DNS setting
 Input format: DEC

IP address of DNS server 1
 IP address of DNS server 2
 IP address of DNS server 3
 IP address of DNS server 4

End Cancel

3.9.2 Open/close processing

The following shows a program example for performing open processing/close processing.

(1) A/AnS series

[Open processing]

The A/AnS series performs open processing by writing communication parameters by the sequence program to buffer memory and turning the open request signal (Y8) ON.

[Close processing]

The A/AnS series performs close processing by turning the open request signal (Y8) OFF, or by the close request (FIN) from an external device.

(a) Program conditions

The following shows a program example for performing open processing (unpassive open) on connection No.1 when initial normal end (X19) turns ON.

Set the communication parameters as follows. (Otherwise, use default values.)

Buffer memory address	Item		Set value
DEC (HEX)			
16 (10 _H)	Connection No.1 application setting area		8000 _H
	Sets the application of the fixed buffer (b0).	0: Transmission	
	Destination existence check setting (b1)	0: Existence check 0: No existence check	
	Pairing open setting (b7)	0: Pairing open 0: Not pairing open	
	Communication method (protocol)	0: TCP/IP	
	Communication protocol setting (b8)		
	Communications using fixed buffer procedure performed/not performed (b9)	0: Performed	
	Open method setting (b15, b14)	10: Unpassive open	
24 (18 _H)	Host port number (For connection No.1)		500 _H

Point

The open processing and the close processing on the Q series have different methods from those on the A/AnS series.

When replacing the A/AnS series with the Q series, refer to Section 3.9.2 (2) and change the program of the open processing and close processing.

(b) Program example

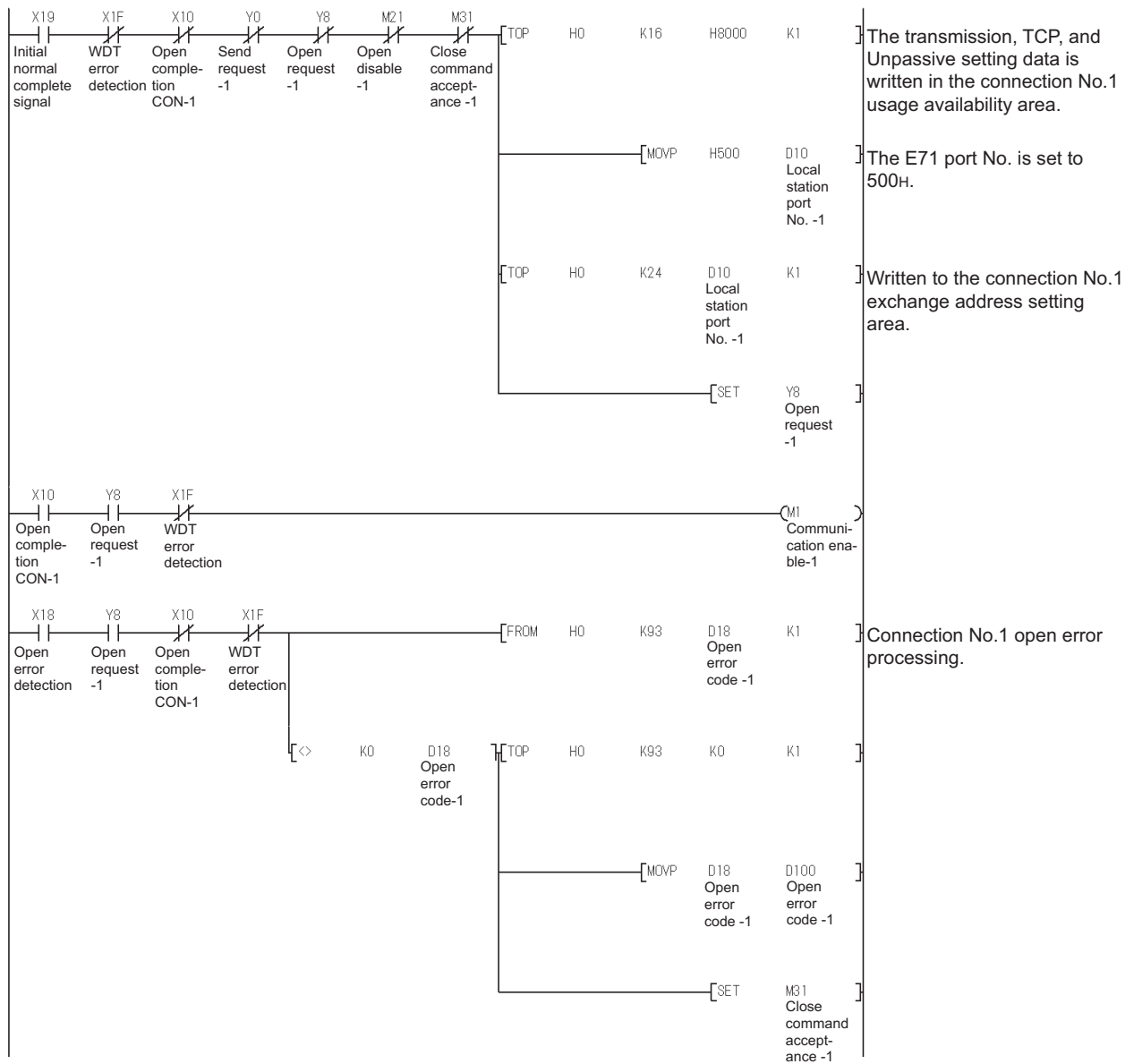

(2) Q series

[Open processing]

The Q series uses the dedicated instruction (OPEN) to perform open processing.

The communication parameters can be set using one of the following methods:

- In the control data of the dedicated instruction (OPEN)
- On GX Developer, select "Network parameter" - "Network Parameter Setting the Number of Ethernet/CC IE/MELSECNET Cards" - (Ethernet) - "Open settings".

[Close processing]

The Q series performs close processing by either using the dedicated instruction (CLOSE), or by the close request (FIN) from an external device.

(a) Program conditions

The following shows a program example for performing open processing (unpassive open) on connection No.1 when initial normal end (X19) turns ON with the initial normal end signal (M5000) ON.

Set the communication parameters in "Network parameters" on GX Developer.

(b) Network parameter setting example

1) "Open settings"

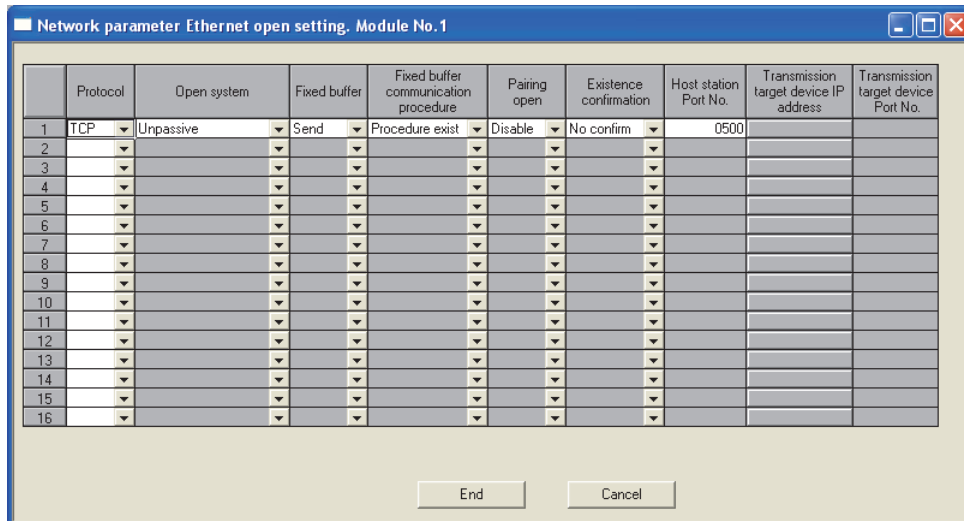

☒ Point

When replacing the A/AnS series with the Q series, change the open processing/close processing program of the A/AnS series to that of the Q series.

(c) Program example

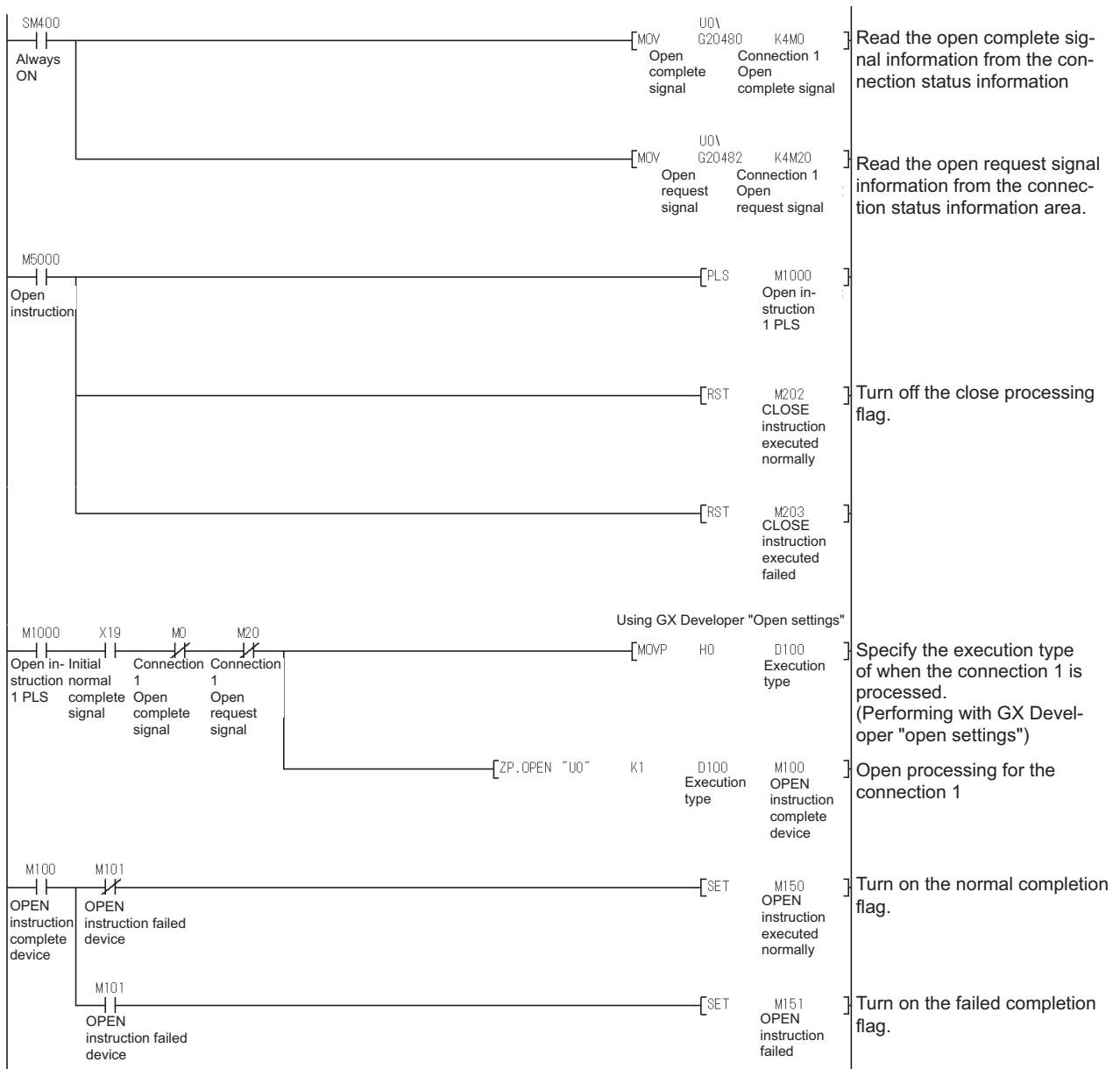

Point

When "Operational settings" - "Initial timing" in GX Developer is set to "Always wait for OPEN", the sequence program for open processing/close processing is not required.

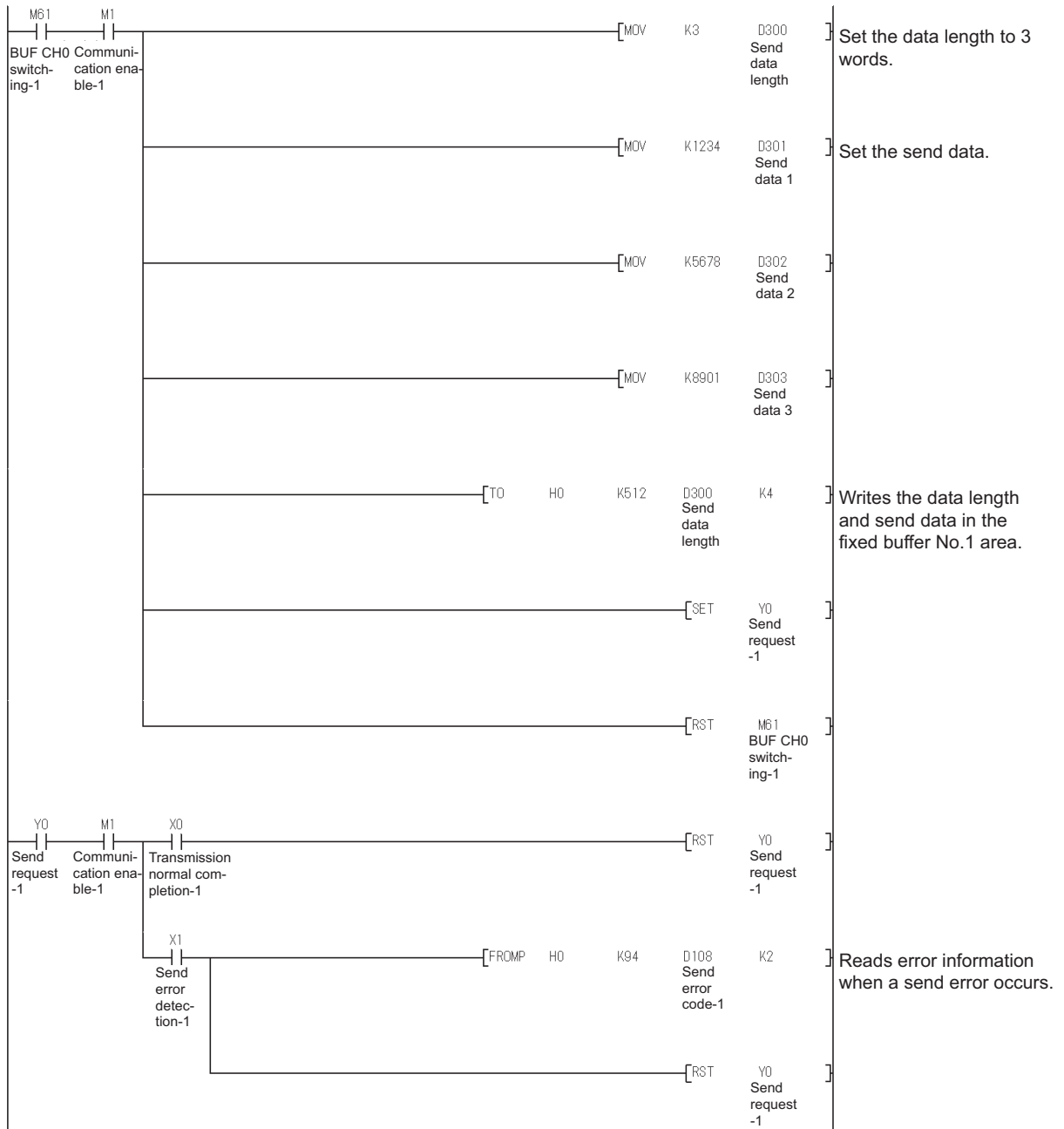

(2) Q series

[Transmission processing]

The Q series uses the dedicated instruction (BUFSND) to perform data transmission from the fixed buffer to an external device.

[Reception processing]

On the Q series, the fixed buffer reception status signal (corresponding bit of address 5005_H) in buffer memory turns ON when data is received to the fixed buffer area.

The Q series uses the dedicated instruction (BUFRCV) to perform data reception.

(a) Program condition

The following shows a program example for performing transmission processing by fixed buffer No.1 when the transmission instruction (M7000) is turned ON.

(b) Program example

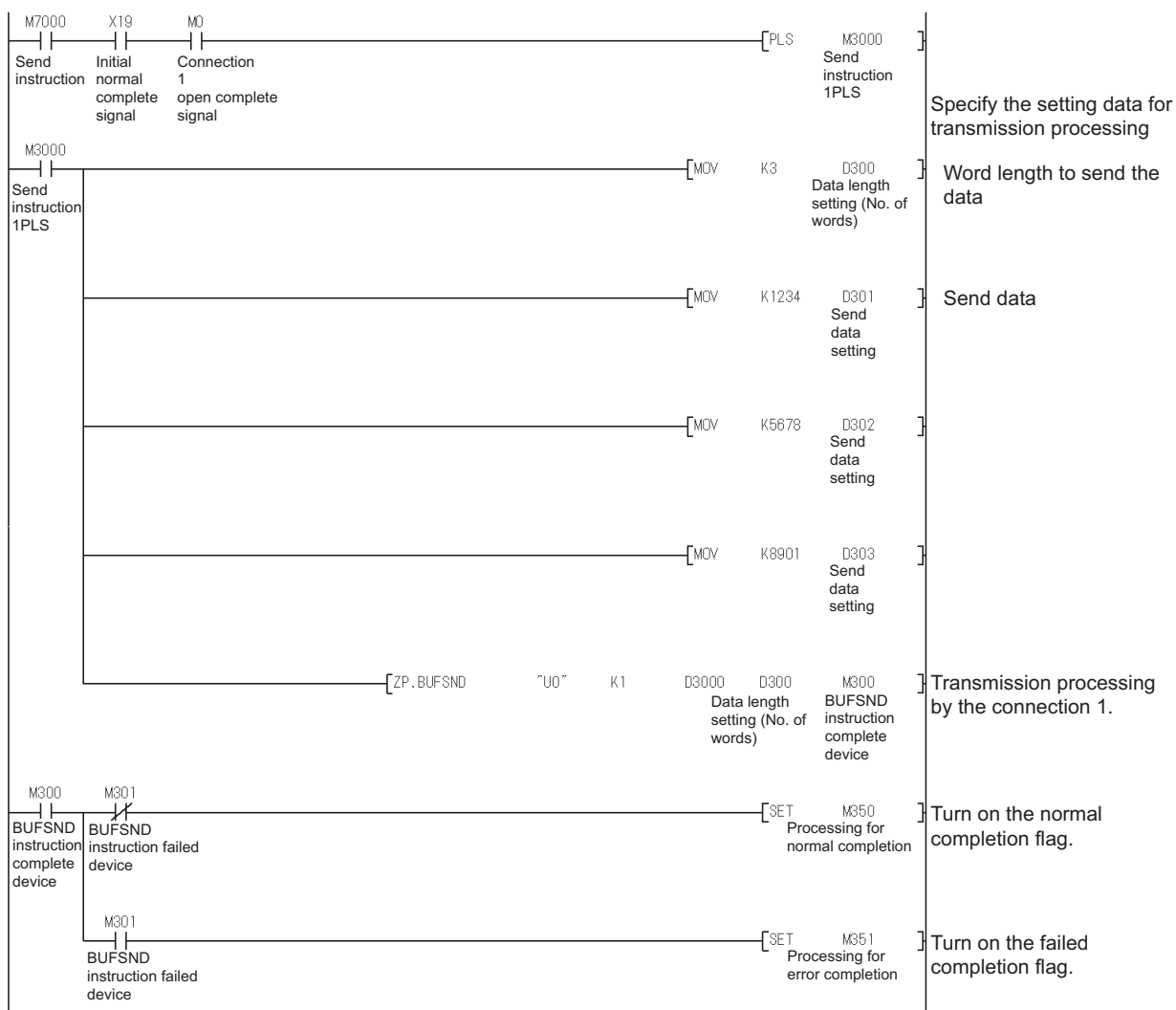

4 INTELLIGENT COMMUNICATION MODULE REPLACEMENT

4.1 List of Intelligent Communication Modules to be Replaced

A/AnS series module	Alternative model	Remarks
AD51H-S3	QD51 ^{*1}	RS-232: 2ch, RS-422/485: none
A1SD51S	QD51-R24 ^{*1}	RS-232: 1ch, RS-422/485: 1ch
AD51-S3		

^{*1} Production of the QD51 and QD51-R24 will be discontinued on February 28, 2017. For details on the production discontinuation, refer to the TECHNICAL BULLETIN (FA-A-0199).

☒ Point

- (1) The serial communication module (QJ71C24N(-R2/R4)) can be used, depending on applications. For details, refer to the TECHNICAL BULLETIN (FA-A-0059).
- (2) Using the QA6□B as an extension base unit allows the AD51-S3/AD51H-S3 to be used in the Q series system.
Using the QA1S6□B allows the A1SD51S to be used in the Q series system.

Remarks

For how to replace the A1SD51S with the QD51(-R24), refer to Appendix 3.

4.2 Performance Specifications Comparison

4.2.1 Module performance comparison

(1) Replacement of intelligent communication module AD51H-S3

○: Compatible, △: Partial change required, ×: Incompatible

Item	Specifications		Compat- ibility	Precautions for replacement	
	AD51H-S3	QD51 QD51-R24			
Programming language	AD51H-BASIC		○		
Number of tasks	8	2	×	Review the BASIC program, and reduce the number of tasks to two or less.	
Task start conditions	<ul style="list-style-type: none"> Start at power on Start by interrupt from the programmable controller CPU (This cannot be performed when Compiler BASIC is used.) Start by start request from another task 		○		
Internal memory	Program	384K bytes (16/32/48/64K bytes selectable for one task.)	Max. 64K bytes (16/32/48/64K bytes selectable for one task.)	×	Review the BASIC program, and reduce the memory size to 64K bytes or less.
	Common memory	8K bytes		○	
	Buffer memory	6K bytes		○	
	Extension relay (EM)	1024 points		○	
	Extension register (ED)	1024 points		○	
General input/output	Input: 27 points Output: 26 points (9 points: For task start from the PLC CPU.)	Input: 26 points Output: 23 points (2 points: For task start from the PLC CPU.)	×	Change I/O signals with a program.	
Memory protection	Yes (Memory card write protectable)	Yes (Flash ROM write protectable)	○		
Interface	RS-232	2 channels	QD51: 2 channels QD51-R24: 1 channel	△	The cable connector must be changed.
	RS-422/485	1 channel	QD51: - QD51-R24: 1 channel	△	Use the QD51-R24.
	Parallel	1 channel	-	×	Consider changing the external devices to RS-232/RS-422 interface devices.
	Memory card	2 slots	-	×	Use CPU module devices.
Clock function	None		○		
Power failure protection	None		○		
User program in ROM	Possible (64KWROM, 128KWROM, 256KWROM)	Possible (Stored in the built-in Flash ROM)	○		
Console	<ul style="list-style-type: none"> A7PHP A7HGP A7LMS VG-620 VT-382 IBM-PC/AT-compatible personal computer 	<ul style="list-style-type: none"> IBM-PC/AT-compatible personal computer 	△	Use an IBM-PC/AT-compatible personal computer. The AD51H-BASIC software package can be used with the QD51(-R24). (This package can be also used with the A series.)	
Multitask debugging	Possible (when a debugger is used.)		○		
I/O points occupied	48 points (The first 16 points are open and the last 32 points are special.)	32 points	×	Change the start I/O No. in the PLC parameter I/O assignment setting.	
No. of slots	2 slots	1 slot	×		

(2) Replacement of intelligent communication module A1SD51S

○: Compatible, △: Partial change required, ×: Incompatible

Item	Specifications		Compat- ibility	Precautions for replacement	
	A1SD51S	QD51 QD51-R24			
Programming language	AD51H-BASIC (interpreter, compile)		○		
Number of tasks	2		○		
Task start conditions	<ul style="list-style-type: none"> • Start at power on • Start by interrupt from the programmable controller CPU (This cannot be performed when Compiler BASIC is used.) • Start by start request from another task 		○		
Internal memory	Program	Max. 64K bytes (16/32/48/64K bytes selectable for one task.)	×	Review the BASIC program, and reduce the memory size to 64K bytes or less.	
	Common memory	8K bytes	○		
	Buffer memory	6K bytes	○		
	Extension relay (EM)	1024 points	○		
	Extension register (ED)	1024 points	○		
General input/output	Input: 27 points Output: 26 points (9 points: For task start from the PLC CPU.)	Input: 26 points Output: 23 points (2 points: For task start from the PLC CPU.)	×	Change I/O signals with a program.	
Memory protection	Yes (E ² PROM write protectable)	Yes (Flash ROM write protectable)	○		
Interface	RS-232	2 channels	QD51: 2 channels QD51-R24: 1 channel	△	The cable connector must be changed.
	RS-422/485	1 channel	QD51: - QD51-R24: 1 channel	△	Use the QD51-R24.
Clock function	None		○		
Power failure protection	Yes (common memory, extension relay, extension register)	None	○	Refer to Section 4.6.2 (4).	
User program in ROM	Possible (Stored in the built-in EEPROM)	Possible (Stored in the built-in flash ROM)	○		
Console	<ul style="list-style-type: none"> • A7PHP • A7HGP • A7LMS • VG-620 • VT-382 • IBM-PC/AT-compatible personal computer 	<ul style="list-style-type: none"> • IBM-PC/AT-compatible personal computer 	△	Use an IBM-PC/AT-compatible personal computer. The AD51H-BASIC software package can be used with the QD51(-R24). (This package can be also used with the A series.)	
Multitask debugging	Possible (when a debugger is used.)		○		
I/O points occupied	32 points (I/O assignment: special 32 points)	32 points (I/O assignment: intelli 32 points)	○		
No. of slots	1 slot		○		

(3) Replacement of intelligent communication module AD51-S3

The BASIC program of AD51-S3 is incompatible with that of QD51/QD51-R24. Analyze the existing program to create a program with AD51H-BASIC.

○: Compatible, △: Partial change required, ×: Incompatible

Item	Specifications		Compat- ibility	Precautions for replacement	
	AD51-S3	QD51 QD51-R24			
Programming language	GPC-BASIC	AD51H-BASIC	×	Change the BASIC program to AD51H-BASIC.	
Number of tasks	Max. 8	2	×	Review the BASIC program, and reduce the number of tasks to two or less.	
Task start conditions	<ul style="list-style-type: none"> Start at power on Start by interrupt from the programmable controller CPU (Impossible when compiled BASIC is run.) Start by a real time interrupt 	<ul style="list-style-type: none"> Start at power on Start by interrupt from the programmable controller CPU (This cannot be performed when Compiler BASIC is used.) Start by start request from another task 	△	When the task is started using a real time interrupt, the condition must be changed.	
Internal memory	Program	Max. 64K bytes + 48K bytes (when using ROM)	×	Review the BASIC program, and reduce the memory size to 64K bytes or less.	
	Common memory	2K bytes	○		
	Buffer memory	6K bytes		○	
	Extension relay (EM)	-	1024 points	-	
	Extension register (ED)	-	1024 points	-	
General input/output	Input: 13 points Output: 10 points	Input: 26 points Output: 23 points	×	Change I/O signals with a program.	
Interface	RS-232	2 channels (Channels 3 and 4)	QD51: 2 channels (Channels 1 and 2) QD51-R24: 1 channel (Channel 1)	△	The cable connector must be changed.
	RS-422	2 channels (Channel 1: connector Channel 2: terminal block)	-	△	Use the QD51-R24.
	RS-422/485	2 channels (Channels 3 and 4)	QD51: - QD51-R24: 1 channel (Channel 2)		
Power failure protection	Yes	None	×		
User program in ROM	Possible (8K ROM/16K ROM)	Possible (Stored in the built-in flash ROM)	○		
Console	<ul style="list-style-type: none"> A6GPP A6HGP A6PHP VG-620 	<ul style="list-style-type: none"> IBM-PC/AT-compatible personal computer 	△	Use an IBM-PC/AT-compatible personal computer. The software package for the system start-up, which was used on the AD51-S3, cannot be used. Use the AD51H-BASIC software package supporting the QD51 (-R24).	
I/O points occupied	48 points (The first 16 points are open and the last 32 points are special.)	32 points	×	Change the start I/O No. in the PLC parameter I/O assignment setting.	
No. of slots	2 slots	1 slot	×		

4.2.2 Cable specifications comparison

(1) Replacement of intelligent communication modules AD51H-S3/A1SD51S

○: Compatible, △: Partial change required, ×: Incompatible

Item	Specifications			Compat- ibility	Precautions for replacement																	
	AD51H-S3	A1SD51S	QD51 QD51-R24																			
RS-232	Cable	Use a cable that is compliant with the RS-232 standard.*1			○																	
	Cable length	Max. 15m			○																	
	Applicable connector for external wiring (module side of connection cable)	D-Sub 25P (male, screw type)	D-Sub 9P*2 (male, screw type)	D-Sub 9P*2 (male, screw type)	△	Change the connector.																
RS-422/485	Cable	<table border="1"> <thead> <tr> <th>Item</th> <th>Description</th> </tr> </thead> <tbody> <tr> <td>Cable type</td> <td>Shielded cable</td> </tr> <tr> <td>Number of pairs</td> <td>3</td> </tr> <tr> <td>Conductor resistance (20°C)</td> <td>88.0 Ω/km or less</td> </tr> <tr> <td>Insulation resistance</td> <td>10000 M Ω·km or more</td> </tr> <tr> <td>Dielectric withstand voltage</td> <td>500 VDC for 1 minute</td> </tr> <tr> <td>Electrostatic capacitance (1kHz)</td> <td>Average 60nF/km or less</td> </tr> <tr> <td>Characteristic impedance (100kHz)</td> <td>110±10 Ω</td> </tr> </tbody> </table> <p>*1</p>			Item	Description	Cable type	Shielded cable	Number of pairs	3	Conductor resistance (20°C)	88.0 Ω/km or less	Insulation resistance	10000 M Ω·km or more	Dielectric withstand voltage	500 VDC for 1 minute	Electrostatic capacitance (1kHz)	Average 60nF/km or less	Characteristic impedance (100kHz)	110±10 Ω	○	
	Item	Description																				
	Cable type	Shielded cable																				
Number of pairs	3																					
Conductor resistance (20°C)	88.0 Ω/km or less																					
Insulation resistance	10000 M Ω·km or more																					
Dielectric withstand voltage	500 VDC for 1 minute																					
Electrostatic capacitance (1kHz)	Average 60nF/km or less																					
Characteristic impedance (100kHz)	110±10 Ω																					
Cable length	Max. 500m		Max. 1200m	○																		
External wiring (module side of connection cable)	D-Sub 25P (male, screw type)		Terminal block	△	Change the connector.																	

*1 Recommended RS-232 and RS-422/485 cables are listed in the Q series intelligent communication module manual.

*2 Use an exclusive connector shell listed in the Q series intelligent communication module manual for the cable to be connected to a Q series intelligent communication module.

(2) Replacement of intelligent communication module AD51-S3

○: Compatible, △: Partial change required, ×: Incompatible

Item	Specifications		Compat- ibility	Precautions for replacement																	
	AD51-S3	QD51 QD51-R24																			
RS-232	Cable	Use a cable that is compliant with the RS-232 standard.*1		○																	
	Cable length	Max. 15m		○																	
	Applicable connector for external wiring (module side of connection cable)	D-Sub 25P (male, screw type)	D-Sub 9P*2 (male, screw type)	△	Change the connector.																
RS-422	Cable	Same as the RS-422/485	-	△	The Q series does not have the RS-422 interface. The interface used must be changed.																
	Applicable connector for external wiring (module side of connection cable)	D-Sub 25P (male, screw type)	Connection to the RS-232 or RS-422/485 interface	△																	
RS-422/485	Cable	<table border="1"> <thead> <tr> <th>Item</th> <th>Description</th> </tr> </thead> <tbody> <tr> <td>Cable type</td> <td>Shielded cable</td> </tr> <tr> <td>Number of pairs</td> <td>3</td> </tr> <tr> <td>Conductor resistance (20°C)</td> <td>88.0Ω/km or less</td> </tr> <tr> <td>Insulation resistance</td> <td>10000 M Ω·km or more</td> </tr> <tr> <td>Dielectric withstand voltage</td> <td>500 VDC for 1 minute</td> </tr> <tr> <td>Electrostatic capacitance (1kHz)</td> <td>Average 60nF/km or less</td> </tr> <tr> <td>Characteristic impedance (100kHz)</td> <td>110±10Ω</td> </tr> </tbody> </table>		Item	Description	Cable type	Shielded cable	Number of pairs	3	Conductor resistance (20°C)	88.0Ω/km or less	Insulation resistance	10000 M Ω·km or more	Dielectric withstand voltage	500 VDC for 1 minute	Electrostatic capacitance (1kHz)	Average 60nF/km or less	Characteristic impedance (100kHz)	110±10Ω	○	
		Item	Description																		
		Cable type	Shielded cable																		
Number of pairs		3																			
Conductor resistance (20°C)		88.0Ω/km or less																			
Insulation resistance		10000 M Ω·km or more																			
Dielectric withstand voltage		500 VDC for 1 minute																			
Electrostatic capacitance (1kHz)		Average 60nF/km or less																			
Characteristic impedance (100kHz)	110±10Ω																				
	*1																				
Cable length	500m	Max. 1200m (overall cable distance)	○																		
External wiring (module side of connection cable)	Connection to the terminal block		○	For the connection method, refer to the manual for the module used.																	

*1 Recommended RS-232 and RS-422/485 cables are listed in the Q series intelligent communication module manual.

*2 Use an exclusive connector shell listed in the Q series intelligent communication module manual for the cable to be connected to a Q series intelligent communication module.

4.3 Function Comparison

(1) Replacement of intelligent communication modules AD51H-S3/A1SD51S

○: Compatible, △: Partial change required, ×: Incompatible

Item		Specifications		Compat- ibility	Precautions for replacement
		AD51H-S3 A1SD51S	QD51 QD51-R24		
Functions by BASIC programs	Sub-CPU Function	Complex numerical and functional calculations which would lengthen the programmable controller CPU's scan time can be done by a BASIC program. • Collection, analysis and correction of measurement data • Function calculations such as Sin, Log and square roots, etc.		○	
	Monitor Display Function	This displays the operating status (production conditions, running status, breakdown etc.) on a console or terminal connected to the module.		○	
	Key Input Function	This allows input of production schedules, production quantity, operations, setting data, etc. from the keyboard of a console or terminal connected to the module.		○	
	Printer Function	This prints out production plans, results, daily reports, breakdown, planning data, inspection results, test results charts, etc. with a printer connected to the module.		○	
	Data Input Function	This enables input of data from a bar code reader, a magnetic card reader, etc. that is connected to the module. (Since transmission is available in a free format through a BASIC program, it will suit any protocol of the opposite device.) • Input of production lot No., product name, quantity, etc. • Collection of measured values, test data		○	
	External Device Connection Function	This allows connection to a computer to the RS-232C or RS-422/485 interface and sends and receives data through a BASIC program.		○	
	Clock Function	This writes and reads clock data (year, month, day, hour, minute, second, day of week) of a programmable controller CPU with the clock function.		○	
Online Programming Function		This creates, executes and corrects BASIC programs through system commands by connecting a console to the module. It also writes and reads execution programs to a Flash ROM by system commands.		○	
Multitask Debugging Function		This multitask function allows debugging while running BASIC programs by connecting a console and a debugger to the module.		○	

(2) Replacement of intelligent communication module AD51-S3

○: Compatible, △: Partial change required, ×: Incompatible

Item		Specifications		Compat- ibility	Precautions for replacement
		AD51-S3	QD51 QD51-R24		
Functions by BASIC programs	Sub-CPU Function	Complex numerical and functional calculations which would lengthen the programmable controller CPU's scan time can be done by a BASIC program. • Collection, analysis and correction of measurement data • Function calculations such as Sin, Log and square roots, etc.		○	The BASIC program of the AD51-S3 is incompatible with that of the QD51/QD51-R24. Analyze the existing program to create a program with AD51H-BASIC.
	Monitor Display Function	This displays the operating status (production conditions, running status, breakdown, etc.) on a console or terminal connected to the module.		○	
	Key Input Function	This allows input of production schedules, production quantity, operations, setting data, etc. from the keyboard of a console or terminal connected to the module.		○	
	Printer Function	This prints out production plans, results, daily reports, breakdown, planning data, inspection results, test results charts, etc. with a printer connected to the module.		○	
	Data Input Function	This enables input of data from a bar code reader, a magnetic card reader, etc. that is connected to the module. (Since transmission is available in a free format through a BASIC program, it will suit any protocol of the opposite device.) • Input of production lot No., product name, quantity, etc. • Collection of measured values, test data		○	
	External Device Connection Function	This allows connection to a computer to the RS-232C or RS-422/485 interface and sends and receives data through a BASIC program.		○	
	Clock Function	This writes and reads clock data (year, month, day, hour, minute, second, day of week) of a programmable controller CPU with the clock function.		○	
Online Programming Function		This creates, executes and corrects BASIC programs through system commands by connecting a console to the module. It also writes and reads execution programs to a Flash ROM by system commands.		○	
Multitask Debugging Function		-	This multitask function allows debugging while running BASIC programs by connecting a console and a debugger to the module.	-	

4.4 Switch Setting

(1) Replacement of intelligent communication module AD51H-S3

○: Compatible, △: Partial change required, ×: Incompatible

Switch name			Specifications		Compat- ibility	Precautions for replacement															
			AD51H-S3	QD51 QD51-R24																	
Mode setting switch 1			0 or 1: Execution mode 2 or 3: Multitask debugging mode 4: Programming 5 to F: Unusable																		
Mode setting switch 2	SW1 to SW5	Console or debug port setting	Set by the combination of devices to be used as a console and a debugger.*1	-	△	Set the switches in the GX Developer's PLC parameter settings.															
	SW6	BASIC program operation stop by [BREAK]/[Ctrl] + [C] keys.	OFF: Disabled ON: Enabled																		
	SW7	Boot target of execution program	OFF: Memory card priority ON: EP-ROM priority	-	-		Execution programs are stored in a flash ROM.														
	SW8	Scheduled time of task	OFF: 50ms ON: 100ms	-	-		The scheduled time of task must be fixed to 50ms.														
Switch 2	SW1	Operation of the AD51H when resetting a programmable controller CPU	OFF: Reset signal invalid ON: Reset signal valid	-	-	The reset signal of programmable controller CPU is valid.															
	SW2	Time accessible by FROM/TO instructions from a programmable controller CPU when resetting the AD51H	<table border="1"> <thead> <tr> <th>SW2</th> <th>SW3</th> <th>Accessible time</th> </tr> </thead> <tbody> <tr> <td>OFF</td> <td>OFF</td> <td>200 ms</td> </tr> <tr> <td>OFF</td> <td>ON</td> <td>500 ms</td> </tr> <tr> <td>ON</td> <td>OFF</td> <td>1000 ms</td> </tr> <tr> <td>ON</td> <td>ON</td> <td>2000 ms</td> </tr> </tbody> </table>	SW2	SW3	Accessible time	OFF	OFF	200 ms	OFF	ON	500 ms	ON	OFF	1000 ms	ON	ON	2000 ms	-	△	Set the switches in the GX Developer's PLC parameter settings. (Select 200ms or 2000ms.)
	SW2			SW3	Accessible time																
	OFF			OFF	200 ms																
	OFF			ON	500 ms																
	ON	OFF	1000 ms																		
	ON	ON	2000 ms																		
SW3																					
SW4	-	Fixed to OFF	-	-																	
SW5	-	Fixed to OFF	-	-																	
SW6	EP-ROM type to be used	OFF: 64kROM/128kROM ON: 256kROM	-	-	No EP-ROM																
SW7	Terminal resistor setting	SW7 and SW8 are both OFF: Without terminal resistor SW7 and SW8 are both ON: With terminal resistor	-	△	Connect the included terminal resistor.																
SW8																					
Memory-protect range switch	SW1	Memory-protect range 0 to 0FFFFh	OFF: Not protected ON: Protected	-	△	The write protect setting of a flash ROM is available. Set the switches in the GX Developer's PLC parameter settings.															
	SW2	10000 to 1FFFFh																			
	SW3	20000 to 2FFFFh																			
	SW4	30000 to 3FFFFh																			
	SW5	40000 to 4FFFFh																			
	SW6	50000 to 5FFFFh																			
	SW7	60000 to 6FFFFh																			
	SW8	70000 to 7FFFFh																			

*1 The next page shows the settings of mode setting switch 2 that vary by the combination of devices to be used as consoles and debuggers.

Mode Setting Switch	Console	Debugger					
		None	RS-422 (CH3)	RS-232C (CH1)		RS-232C (CH2)	
			A7PHP/ A7HGP/ A7LMS/ IBM-PC/AT- compatible	VT-382/ IBM-PC/AT- compatible	VG-620	VT-382/ IBM-PC/AT- compatible	VG-620
<p>Mode setting switch 2</p> <p>ON ←</p> <p>(Set each switch to the ■ side.)</p>	A7PHP A7HGP A7LMS IBM-PC/AT- compatible series (Connected to CH3)		-				
	VT-382 IBM-PC/AT- compatible series (Connected to CH1)			-	-		-
	VG-620 (Connected to CH1)			-	-	-	
	None						

(2) Replacement of intelligent communication module A1SD51S

○: Compatible, △: Partial change required, ×: Incompatible

Switch name			Specifications		Compat- ibility	Precautions for replacement
			A1SD51S	QD51 QD51-R24		
Mode setting switch 1			0 or 1: Execution mode 2 or 3: Multitask debugging mode 4: Programming 5 to F: Unusable			
Mode setting switch 2	SW1 to SW5	Console or debug port setting	Set by the combination of devices to be used as a console and a debugger.*1	-	△	Set the switches in the GX Developer's PLC parameter settings.
	SW6	BASIC program operation stop by [BREAK]/[Ctrl] + [C] keys.	OFF: Disabled ON: Enabled			
	SW7	Operation of the A1SD51S when the programmable controller CPU is reset	Set the reset signal from the programmable controller CPU to valid or invalid. OFF: Reset signal invalid ON: Reset signal valid	-	-	There is no setting of valid or invalid. The reset signal of the programmable controller CPU is valid.
	SW8	The time for how long the programmable controller CPU can access to the A1SD51S using the FROM/TO instructions after the A1SD51S is reset	OFF: 200ms ON: 2000ms	-	△	Set the switches in the GX Developer's PLC parameter settings. (Select 200ms or 2000ms.)
	SW9	Backup area clear setting	OFF: Clear disabled ON: Clear enabled	-	×	Common memory is not backed up by a battery. To save data, use the file register or latch device of the programmable controller CPU.
	SW10	E ² PROM write protect setting	OFF: Write protection OFF ON: Write protection ON	-	△	Write protect can be set for a flash ROM. Set the switches in the GX Developer's PLC parameter settings.
	SW11 SW12	(Not used)	- -	- -	- -	

*1 The next page shows the settings of mode setting switch 2 that vary by the combination of devices to be used as consoles and debuggers.

Mode Setting Switch	Console	Debugger					
		None	RS-422 (CH3)	RS-232C (CH1)		RS-232C (CH2)	
			A7PHP/ A7HGP/ A7LMS/ IBM-PC/AT- compatible	VT-382/ IBM-PC/AT- compatible	VG-620	VT-382/ IBM-PC/AT- compatible	VG-620
<p>Mode setting switch 2</p> <p>(Set each switch to the ■ side.)</p>	A7PHP A7HGP A7LMS IBM-PC/AT- compatible series (Connected to CH3)		-				
	VT-382 IBM-PC/AT- compatible series (Connected to CH1)			-	-		-
	VG-620 (Connected to CH1)			-	-	-	
	None						

(3) Replacement of intelligent communication module AD51-S3

○: Compatible, △: Partial change required, ×: Incompatible

Switch name		Specifications		Compat- ibility	Precautions for replacement												
		AD51-S3	QD51 QD51-R24														
DIP switch	SW1	Memory protect range	48K bytes of the RAM area may be used for memory protect setting in units of 8K bytes. The system data area may also be used for the setting.*1	-	△	The write protect setting of a flash ROM is available. Set the switches in the GX Developer's PLC parameter settings.											
	SW2																
	SW3																
	SW4																
	SW5																
	SW6																
	SW7																
	SW8	-	Fixed to OFF	-	-												
	SW9																
	SW10																
	SW11																
	SW12																
	SW13	Terminal resistor	SW14 and SW15 are both OFF: Without terminal resistor SW14 and SW15 are both ON: With terminal resistor	-	△	Connect the included terminal resistor.											
	SW14																
	SW15	Console channel	<table border="1"> <thead> <tr> <th>SW16 Position</th> <th>CH1 (RS-422)</th> <th>CH3 (RS-232C)</th> </tr> </thead> <tbody> <tr> <td>ON</td> <td>GPP/HGP/PHP</td> <td>General port</td> </tr> <tr> <td>OFF</td> <td>General port</td> <td>VG-670/A6GPP</td> </tr> </tbody> </table>	SW16 Position	CH1 (RS-422)	CH3 (RS-232C)	ON	GPP/HGP/PHP	General port	OFF	General port	VG-670/A6GPP	-	△	Set the switches in the GX Developer's PLC parameter settings.		
	SW16 Position		CH1 (RS-422)	CH3 (RS-232C)													
	ON		GPP/HGP/PHP	General port													
	OFF	General port	VG-670/A6GPP														
SW16	<table border="1"> <thead> <tr> <th>SW17 Position</th> <th>8000H to 8004H Data</th> <th>Description</th> </tr> </thead> <tbody> <tr> <td rowspan="2">ON</td> <td>Specific pattern</td> <td>System data is transferred from channel 1 addresses 8000H to 80FFH to system data area, 4F00H to 4FFFH.</td> </tr> <tr> <td>Unspecific pattern</td> <td>Not transferred.</td> </tr> <tr> <td rowspan="2">OFF</td> <td>Specific pattern</td> <td>Not transferred.</td> </tr> <tr> <td>Unspecific pattern</td> <td>Not transferred.</td> </tr> </tbody> </table>	SW17 Position	8000H to 8004H Data	Description	ON	Specific pattern	System data is transferred from channel 1 addresses 8000H to 80FFH to system data area, 4F00H to 4FFFH.	Unspecific pattern	Not transferred.	OFF	Specific pattern	Not transferred.	Unspecific pattern	Not transferred.	-	-	For AD51H-BASIC, the system data is not needed.
	SW17 Position	8000H to 8004H Data	Description														
ON	Specific pattern	System data is transferred from channel 1 addresses 8000H to 80FFH to system data area, 4F00H to 4FFFH.															
	Unspecific pattern	Not transferred.															
OFF	Specific pattern	Not transferred.															
	Unspecific pattern	Not transferred.															
SW17	System data transfer																
SW18	-	Fixed to OFF	-	-													

*1 Memory protect area

The shaded areas  in the memory maps below can be memory-protected.

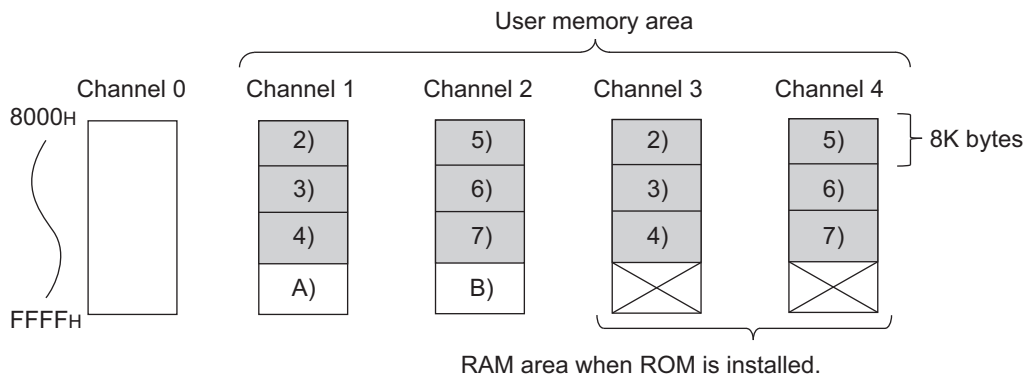
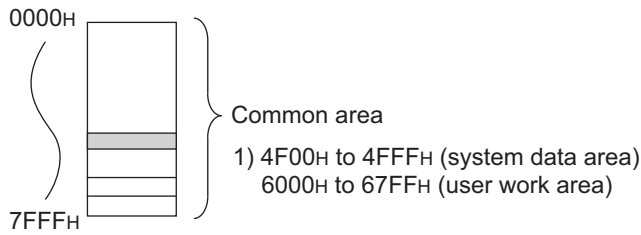

Remarks

- (1) The memory protect DIP switch number is shown as 1) to 7) in the above memory map.
- (2) The memory protect DIP switch numbers for a given RAM address range remain unchanged when ROM is loaded although the channel number has changed from channel 1 to 2 or from 3 to 4.

4.5 Program Comparison

4.5.1 I/O signal

(1) Replacement of intelligent communication module AD51H-S3

○: Compatible, △: Partial change required, ×: Incompatible

Input signal	AD51H-S3	QD51 QD51-R24	Compat- ibility	Precautions for replacement	
X0	Use prohibited	General input	△	Change "X10 to X1D" to "X0 to XD", and "X20 to X2F" to "X10 to X1D".	
X1			△		
X2			△		
X3			△		
X4			△		
X5			△		
X6			△		
X7			△		
X8			△		
X9			△		
XA			△		
XB			Multitask execution start		△
XC			Multitask stop		△
XD			QD51 (-R24) system down		△
XE			QD51 (-R24) operating status		△
XF	Use prohibited	△			
X10	General input	General input	△		
X11			△		
X12			△		
X13			△		
X14			△		
X15			△		
X16			△		
X17			△		
X18			△		
X19			△		
X1A	△				
X1B	Multitask execution start	△			
X1C	Multitask stop	△			
X1D	AD51H system down	△			
X1E	Use prohibited	Use prohibited	△		
X1F			△		
X20	General input	Outside I/O point range	△		
to			△		
X2F			△		

○: Compatible, △: Partial change required, ×: Incompatible

Output signal	AD51H-S3	QD51 QD51-R24	Compat-ibility	Precautions for replacement
Y0	Unused (Can be used for internal relay (M.))	General output	△	Change "Y10 to Y20" to "Y0 to Y10" and "Y13 to Y18". In addition, change "Y21 to Y28" to "Y11 to Y12" with the task divided into two.
Y1			△	
Y2			△	
Y3			△	
Y4			△	
Y5			△	
Y6			△	
Y7			△	
Y8			△	
Y9			△	
YA			△	
YB			△	
YC			△	
YD			△	
YE			△	
YF			△	
Y10	General output	General output/Start BASIC task No.1 designation	△	
Y11			△	
Y12		General output/Start BASIC task No.2 designation	△	
Y13			△	
Y14		General output	△	
Y15			△	
Y16			△	
Y17			△	
Y18			△	
Y19			△	
Y1A		Task start signal	△	
Y1B		Reset request signal	△	
Y1C		Use prohibited	△	
Y1D			△	
Y1E	△			
Y1F	△			
Y20	General output/Start BASIC task No. designation	Outside I/O point range	△	
Y21			△	
Y22			△	
Y23			△	
Y24			△	
Y25			△	
Y26			△	
Y27			△	
Y28	△			
Y29	Program start signal	△		
Y2A to Y2F	Use prohibited	△		

(2) Replacement of intelligent communication module A1SD51S

○: Compatible, △: Partial change required, ×: Incompatible

Input signal	A1SD51S	QD51 QD51-R24	Compat- ibility	Precautions for replacement
X0	General input	General input	○	
X1			○	
X2			○	
X3			○	
X4			○	
X5			○	
X6			○	
X7			○	
X8			○	
X9			○	
XA			○	
XB	Multitask execution start	Multitask execution start	○	
XC	Multitask stop	Multitask stop	○	
XD	A1SD51S system down	QD51 (-R24) system down	○	
XE	Use prohibited	QD51 (-R24) operating status	○	
XF		Use prohibited	○	
X10	General input	General input	○	
X11			○	
X12			○	
X13			○	
X14			○	
X15			○	
X16			○	
X17			○	
X18			○	
X19			○	
X1A			○	
X1B			○	
X1C			○	
X1D			○	
X1E			○	
X1F		Use prohibited	×	

○: Compatible, △: Partial change required, ×: Incompatible

Output signal	A1SD51S	QD51 QD51-R24	Compatibility	Precautions for replacement
Y0	General output	General output	○	
Y1			○	
Y2			○	
Y3			○	
Y4			○	
Y5			○	
Y6			○	
Y7			○	
Y8			○	
Y9			○	
YA			○	
YB	○			
YC	○			
YD	○			
YE	○			
YF	○			
Y10	○			
Y11	General output/Start BASIC task No.1 designation	General output/Start BASIC task No.1 designation	○	
Y12	General output/Start BASIC task No.2 designation	General output/Start BASIC task No.2 designation	○	
Y13	General output	General output	○	
Y14			○	
Y15			○	
Y16			○	
Y17			○	
Y18			○	
Y19	Task start signal	Task start signal	○	
Y1A	Reset request signal	Reset request signal	○	
Y1B	Use prohibited	Use prohibited	○	
Y1C			○	
Y1D			○	
Y1E			○	
Y1F			○	

(3) Replacement of intelligent communication module AD51-S3

○: Compatible, △: Partial change required, ×: Incompatible

Input signal	AD51H-S3	QD51 QD51-R24	Compat- ibility	Precautions for replacement	
X0	Use prohibited	General input	△		
X1			△		
X2			△		
X3			△		
X4			△		
X5			△		
X6			△		
X7			△		
X8			△		
X9			△		
XA			△		
XB			Multitask execution start		△
XC			Multitask stop		△
XD			QD51 (-R24) system down		△
XE			QD51 (-R24) operating status		△
XF	Use prohibited	△			
X10	General input	General input	△	Change "X10 to X1C" to "X0 to XA", and "X10 to X1F". Also, change X1D to XD.	
X11			△		
X12			△		
X13			△		
X14			△		
X15			△		
X16			△		
X17			△		
X18			△		
X19			△		
X1A			△		
X1B			△		
X1C			△		
X1D			AD51-S3 system down		△
X1E			Use prohibited		Use prohibited
X1F	△				
X20 to X2F	Outside I/O point range	△			

○: Compatible, △: Partial change required, ×: Incompatible

Output signal	AD51-S3	QD51 QD51-R24	Compatibility	Precautions for replacement	
Y0	Unused (Can be used for internal relay (M).)	General output	△	Change "Y20 to Y29" to "Y0 to Y1F". However, when Y29 is used as an interrupt signal, the program must be reviewed.	
Y1			△		
Y2			△		
Y3			△		
Y4			△		
Y5			△		
Y6			△		
Y7			△		
Y8			△		
Y9			△		
YA			△		
YB			△		
YC			△		
YD			△		
YE			△		
YF			△		
Y10			△		
Y11			General output/Start BASIC task No.1 designation		△
Y12			General output/Start BASIC task No.2 designation		△
Y13			General output		△
Y14	△				
Y15	△				
Y16	△				
Y17	△				
Y18	△				
Y19	Task start signal	△			
Y1A	Reset request signal	△			
Y1B	Use prohibited	△			
Y1C		△			
Y1D		△			
Y1E		△			
Y1F		△			
Y20		General output	△		
Y21	△				
Y22	△				
Y23	△				
Y24	△				
Y25	△				
Y26	△				
Y27	△				
Y28	△				
Y29	Turning this ON by sequence program interrupts the AD51 operation.	△			
Y2A to Y2F	Use prohibited	△			

4.5.2 Buffer memory

(1) Replacement of intelligent communication modules AD51H-S3/A1SD51S

There is no difference between the QD51(-R24) and the AD51H-S3/A1SD51S.

(2) Replacement of intelligent communication module AD51-S3

For the buffer memory areas which data are read/written from/to a CPU module, no difference is identified between the QD51(-R24) and the AD51-S3. However, the memory configuration and memory map in the module differ.

4.6 Reuse of Existing Programs

4.6.1 Replacement of intelligent communication module AD51H-S3

(1) Usable channels

Usable channels are as shown below.

O: Usable, x: Unusable.

Item		AD51H-S3	QD51	QD51-R24
Channel	CH. 1 (RS-232)	○	○	○
	CH. 2 (RS-232)	○	○	x
	CH. 3 (RS-422/RS-485)	○	x	○
	CH. 4 (Parallel)	○	x	x

(a) Use in the QD51

Since the QD51 does not have CH. 3 (RS-422/485) and CH. 4 (Parallel) interfaces, using existing programs is not allowed.

Modify the BASIC program for CH. 3 (RS-422/485) to the other channels or use the QD51-R24. CH. 4 (Parallel) is not provided.

(b) Use in the QD51-R24

Since the QD51-R24 does not have CH. 2 (RS-232) and CH. 4 (Parallel) interfaces is not allowed. Modify the BASIC program for CH. 2 (RS-232) to the other channels or use the QD51. CH. 4 (Parallel) is not provided.

(2) Communications specifications

Data bit and stop bit settings differ between the models. Correct the BASIC program.

Item	AD51H-S3	QD51(-R24)
Data bit	5, 6, 7, 8	7, 8
Stop bit	1, 1.5, 2	1, 2

(3) Common memory backup

Common memory backup is as shown below.

Item	AD51H-S3	QD51(-R24)
Common memory	Backed up	Not backed up

In the QD51 (-R24), common memory is not backed up by a battery. If backup is necessary, use the programmable controller CPU's file register (R).

Modify the program that accesses the common memory using GETMEM and PUTMEM instructions to access the file register (R) using PCRD and PCWT instructions.

(4) Maximum number of tasks

The maximum number of tasks that can be run at the same time is as shown below.

Item	AD51H-S3	QD51(-R24)
Max. number of tasks	8	2

In the QD51 (-R24), a maximum of only 2 BASIC programs can be run at a time.

(5) PCRD/PCWT command

The processing codes shown below are not executable for the Q/QnA CPUs. Replace any codes which can be replaced.

(a) PCRD commands

Processing codes used in the AD51H-S3		Processing codes used in the QD51(-R24)	
Processing Code	Contents	Processing Code	Contents
2(&H2)	Monitoring of the devices registered by the PCWT command	515 (&H203)	Reading of Q/QnA series device memory
4(&H4)	Reading of extension file register data		
5(&H5)	Monitoring the extension file register registered by the PCWT command		
7(&H7)	Reading of continuous address designation data in the extension file register		
8(&H8)	Reading of sequence programs	-	Cannot be replaced with Q/QnA series.
9(&H9)	Reading of microcomputer programs		
10(&HA)	Reading of comment data		
11(&HB)	Reading of extension comment data		
12(&HC)	Reading of the buffer memories of a special function module	533 (&H215)	Reading of the buffer memories of a Q/QnA series intelligent function module
13(&HD)	Reading of the model name of a programmable controller CPU	513 (&H201)	Reading of the model name of a Q/QnA programmable controller CPU
14(&HE)	Reading of parameter data (Reading of MELSECNET/10 parameters)	-	Cannot be replaced with Q/QnA series.
21(&H15)	Reading of network information		
22(&H16)	Reading of routing parameters		

(b) PCWT command

Processing codes used in the AD51H-S3		Processing codes used in the QD51(-R24)	
Processing Code	Contents	Processing Code	Contents
2(&H2)	Device memory monitor registration	515 (&H203)	Writing of Q/QnA series device memory
3(&H3)	Random writing to device memory		
4(&H4)	Writing to extension file register		
5(&H5)	Expansion file register monitor registration		
6(&H6)	Random writing to extension file register	-	Cannot be replaced with Q/QnA series.
7(&H7)	Continuous address designation data writing to extension file register		
8(&H8)	Writing of sequence programs		
9(&H9)	Writing of microcomputer programs		
10(&HA)	Writing of comment data	533 (&H215)	Writing to the buffer memories of a Q/QnA series intelligent function module
11(&HB)	Writing of extension comment data		
12(&HC)	Writing of the buffer memories of a special function module	-	Cannot be replaced with Q/QnA series.
14(&HE)	Writing of parameter data (Writing of MELSECNET/10 parameters)		
15(&HF)	Analysis of parameter data		

4.6.2 Replacement of intelligent communication module A1SD51S

(1) Usable channels

Usable channels are as shown below.

○: Usable, ×: Unusable.

Item	A1SD51S	QD51	QD51-R24
CH. 1 (RS-232)	○	○	○
CH. 2 (RS-232)	○	○	×
CH. 3 (RS-422/RS-485)	○	×	○

(a) Use in the QD51

When the A1SD51S is replaced with the QD51, CH.3 (RS-422/485) interface is not available. Modify the BASIC program so that other channels may be used, or use the QD51-R24.

(b) Use in the QD51-R24

Since the QD51-R24 does not have CH. 2 (RS-232) and CH. 4 (Parallel) interfaces is not allowed. When the A1SD51S is replaced with the QD51-R24, CH.2 (RS-232) interface cannot be used. Modify the BASIC program so that other channels may be used, or use the QD51.

(2) Communications specifications

Data bit and stop bit settings differ between the models. Correct the BASIC program.

Item	A1SD51S	QD51(-R24)
Data bit	5, 6, 7, 8	7, 8
Stop bit	1, 1.5, 2	1, 2

(3) Common memory backup

Common memory backup is as shown below.

Item	A1SD51S	QD51(-R24)
Common memory	Backed up	Not backed up

In the QD51 (-R24), common memory is not backed up by a battery. If backup is necessary, use the programmable controller CPU's file register (R).

Modify the program that accesses the common memory using GETMEM and PUTMEM instructions to access the file register (R) using PCRD and PCWT instructions.

(4) Internal memory

(a) Memory to store a program to be executed

There is no difference between the QD51(-R24) and the A1SD51S.

(b) Communication memory

The communication memory for the A1SD51S can be accessed using only the special variable B@/W@. However, the communication memory for the QD51(-R24) can be also accessed using a sequence program (FROM/TO instructions). (The function was added.)

There is no precaution for when using an A1SD51S program for the QD51(-R24).

- Communication memory of the A1SD51S

Item	Description	Address		
		Programmable controller CPU	BASIC program	
		FROM/TO instruction	GETMEM/PUTMEM instruction	Special variableB@/W@
Communication with a programmable controller CPU	Buffer memory	0000 _H to 0BFF _H	0000 _H to 17FF _H	-
Communication between tasks	Common memory	-	1800 _H to 37FF _H	-
Reading/writing of the ON/OFF data	Extension registers	-	-	ED0000 to ED1023
	System area	-	-	-
	Extension relays	-	-	EM0000 to EM1023
	System area	-	-	-
	Special registers	-	-	ED9000 to ED9127
	System area	-	-	-
	Special relays	-	-	EM9000 to EM9127
System area	-	-	-	

- Communication memory of the QD51(-R24)

Item	Description	Address		
		Programmable controller CPU	BASIC program	
		FROM/TO instruction	GETMEM/PUTMEM instruction	Special variableB@/W@
Communication with a programmable controller CPU	Buffer memory	0000 _H to 0BFF _H	0000 _H to 17FF _H	-
Communication between tasks	Common memory	0C00 _H to 1BFF _H	1800 _H to 37FF _H	-
Reading/writing of the ON/OFF data	Extension registers	1C00 _H to 1FFF _H	-	ED0000 to ED1023
	System area	-	-	-
	Extension relays	2380 _H to 23BF _H	-	EM0000 to EM1023
	System area	-	-	-
	Special registers	2400 _H to 247F _H	-	ED9000 to ED9127
	System area	-	-	-
	Special relays	2500 _H to 2507 _H	-	EM9000 to EM9127
System area	-	-	-	

(c) PCRD commands

Processing codes used in the AD51H-S3		Processing codes used in the QD51(-R24)	
Processing Code	Contents	Processing Code	Contents
2(&H2)	Monitoring of the devices registered by the PCWT command	515 (&H203)	Reading of Q/QnA series device memory
4(&H4)	Reading of extension file register data		
5(&H5)	Monitoring the extension file register registered by the PCWT command		
7(&H7)	Reading of continuous address designation data in the extension file register		
8(&H8)	Reading of sequence programs	-	Cannot be replaced with Q/QnA series.
9(&H9)	Reading of microcomputer programs		
10(&HA)	Reading of comment data		
11(&HB)	Reading of extension comment data		
12(&HC)	Reading of the buffer memories of a special function module	533 (&H215)	Reading of the buffer memories of a Q/QnA series intelligent function module
13(&HD)	Reading of the model name of a programmable controller CPU	513 (&H201)	Reading of the model name of a Q/QnA programmable controller CPU
14(&HE)	Reading of parameter data (Reading of MELSECNET/10 parameters)	-	Cannot be replaced with Q/QnA series.
21(&H15)	Reading of network information		
22(&H16)	Reading of routing parameters		

(d) PCWT command

Processing codes used in the AD51H-S3		Processing codes used in the QD51(-R24)	
Processing Code	Contents	Processing Code	Contents
2(&H2)	Device memory monitor registration	515 (&H203)	Writing of Q/QnA series device memory
3(&H3)	Random writing to device memory		
4(&H4)	Writing to extension file register		
5(&H5)	Expansion file register monitor registration		
6(&H6)	Random writing to extension file register		
7(&H7)	Continuous address designation data writing to extension file register		
8(&H8)	Writing of sequence programs	-	Cannot be replaced with Q/QnA series.
9(&H9)	Writing of microcomputer programs		
10(&HA)	Writing of comment data		
11(&HB)	Writing of extension comment data		
12(&HC)	Writing of the buffer memories of a special function module	533 (&H215)	Writing to the buffer memories of a Q/QnA series intelligent function module
14(&HE)	Writing of parameter data (Writing of MELSECNET/10 parameters)	-	Cannot be replaced with Q/QnA series.
15(&HF)	Analysis of parameter data		

(5) DATE\$ function

The processing of the DATE\$ function differs. Therefore, modify the BASIC program.

Processing	A1SD51S	QD51(-R24)	Action
Reading	Reads only the last two digits of the year. When the last two digits is 90 or greater, the first two digits is 19. When the last two digits is 89 or lower, the first two digits is 20.	Reads all the four digits of the year.	Modify the program to use the four digits for processing.
Writing	Writes only the last two digits of the year.	Writes all the four digits of the year.	Selects the four digits.

4.6.3 Replacement of intelligent communication module AD51-S3

The BASIC program language of the QD51(-R24) differs from that of the AD51-S3. For this reason, the program of the AD51-S3 programmed with GPC-BASIC is not reused for the QD51(-R24). Create a new program with AD51H-BASIC.

5 AS-i MASTER MODULE REPLACEMENT

5.1 List of AS-i Master Modules to be Replaced

AnS/QnAS series model		Q series alternative model	
Product name	Model	Model name	Remarks (restrictions)
AS-i master module	A1SJ71AS92	QJ71AS92	(1) Change in external wiring: Yes (2 systems → 1 system 2 groups) ^{*1} (2) Change in the number of slots: Yes If the existing I/O slave uses two systems, it needs to be replaced by two modules. (3) Program change: Change in I/O signals If the existing I/O slave uses two systems, the buffer memory address needs to be changed. (4) Change in performance specifications: Yes AS-i standard (AS-i Ver. 2.04 is compatible.) (5) Change in function specifications: Yes Change in systems (2 systems → 1 system 2 groups)

*1 Wiring methods of system and series

(1) A1SJ71AS92 (2 systems)

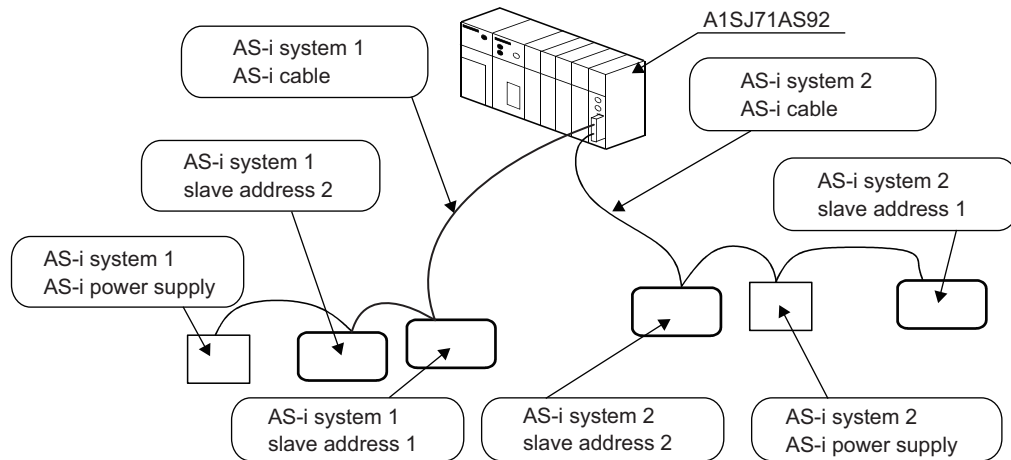

(2) QJ71AS92 (1 system 2 groups)

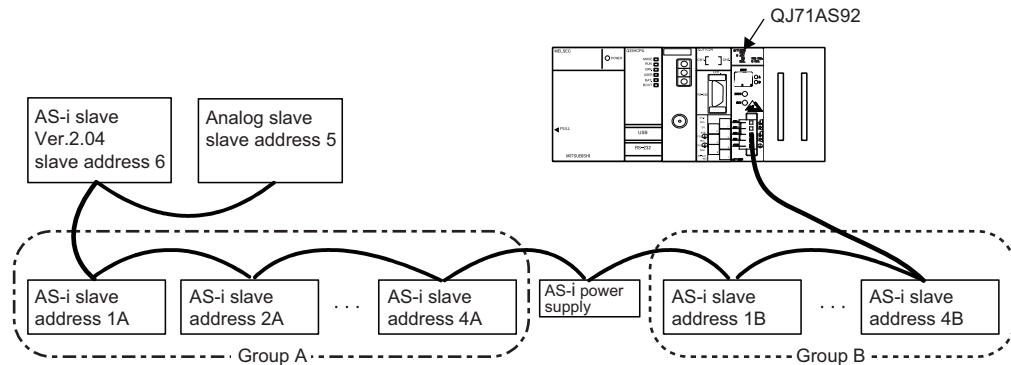

5.2 Performance Specifications Comparison

O: Compatible, Δ: Partly changed, ×: Incompatible

Item	Specifications		Compat- ibility	Precautions for replacement
	A1SJ71AS92	QJ71AS92		
AS-i standard compliance	AS-i Ver.2.04	AS-i Ver.2.04/2.11	○	Compatible standards are increased.
Number of AS-i systems	2 systems	1 system	Δ	System/group are different.
Grouping	Not possible	AS-i Ver.2.11 compatibility: Yes AS-i Ver.2.04 compatibility: No		
Max. number of AS-i slaves	62 (31 × 2 systems)	62 (A group: 31, B group: 31) ^{*1}	Δ	If the existing configuration uses 2 systems, it needs to be replaced by 2 modules.
Connectable slave type	• Ver.2.04-compatible I/O slave	• AS-i Ver. 2.04-compatible I/O slave • AS-i Ver. 2.11-compatible I/O slave • AS-i Ver. 2.11-compatible analog slave	○	Existing slave modules can be used without changing.
Max. number of I/O points (1 point = 1 bit)	Input	248 points (124 points × 2 systems)	○	
	Output	248 points (124 points × 2 systems)		
Max. number of analog I/O points (1 point = 16 bits)	Input	-	○	A1SJ71AS92 is not compatible.
	Output	-		
Input/output refresh time	Approx. 5ms (when maximum number of input/output points are connected)	Approx. 5ms (without I/O slave grouping) Approx. 10ms (with I/O slave grouping) Approx. 35ms (per analog slave channel)	○	
Communication speed	167kbps		○	
Transmission distance	Maximum 100m/system (max. 300m with two repeaters)	Max. 100m (max. 300m with two repeaters)	○	
Connection type	Bus network type, independent for each system. (Star, line, tree or ring)	Bus network type (star, line, tree and ring)	○	
Communication method	APM modulation method (Alternating Pulse Modulation)		○	
Error control system	Parity check		○	
Internal memory	Flash ROM (for registering slave configuration) Number of writes: 10,000 times or less	EEPROM (for parameter registration) number of writes: 100,000 times	Δ	Functions are equivalent although built-in memory is different
Number of occupied I/O points	32 points (I/O assignment: special 32 points)	32 points (I/O assignment: 32 intelligent points)	○	
Cable type	Use dedicated AS-i cable.		○	
Applicable solderless terminal	R2-3.5, RAV 2-3.5, RAP 2-3.5, RBV 2-3.5, RBP 2-3.5 (JIS C2805 compliant)	-	Δ	Directly connected by peeling off the cable cover and therefore the solderless terminal needs to be reprocessed.
External supply power	Voltage	30.5VDC (supplied independently to each system from AS-i power supply)	○	
	Current consumption	70mA/system (TYP 30.5VDC)		
5VDC internal current consumption	0.15A	0.40A	Δ	Internal current consumption (5VDC) needs to be recalculated.
Weight	0.30kg	0.12kg	○	

*1 This is the maximum number of slaves when only Ver.2.11-compatible I/O slaves are configured.
 If analog slaves and Ver.2.04-compatible I/O slaves coexist, calculate the number using the following formula.

$$(N_{IO-A} + N_{IO-B}) + 2 \times (N_A + N_{IO}) \leq 62$$
 N_{IO-A}: Number of Ver.2.11-compatible A-group I/O slaves; N_{IO-B}: Number of B-group I/O slaves, N_A: Number of analog slaves
 N_{IO}: Number of Ver.2.04-compatible I/O slaves

Slave type	Grouping
AS-i Ver. 2.11-compatible I/O slave	Enabled (A-group, B-group)
AS-i Ver. 2.04-compatible I/O slave	Disabled
AS-i Ver. 2.11-compatible analog slave	

5.3 Function Comparison

○: Function available, -: Function unavailable

Item	Description	A1SJ71AS92	QJ71AS92	Precautions for replacement
AS-i slave communication function	Communicates with AS-i slaves.	○	○	
Automatic refresh function by utility package	Automatically refreshes the Q71AS92's I/O data to the CPU module's device memory.	-	○	A1SJ71AS92 allows for this function by using the FROM/TO instructions in the sequence program.
Automatic slave address assignment function	When a slave is replaced with a new one of the same model, this function automatically assigns the previous slave address to the new one that has slave address 0.	○	○	
Parameter setting function	Sets slave addresses and QJ71AS92's parameters by the following:			
	• Utility package	-	○	
	• CODE LED and switches on the module's front face.	-	○	
	• Sequence program	○	○	

5.4 Program Comparison

5.4.1 I/O signals

As different I/O signals are used, the sequence programs need to be reviewed and corrected.
For details of I/O signals, refer to the "AS-i Master Module User's Manual".

○: Compatible, △: Partly changed, ×: Incompatible

I/O signals	Signal name		Compat- ibility	Precautions for replacement
	A1SJ71AS92	QJ71AS92		
X00	Watchdog Timer Error (WDT error)	Module Ready	×	The device numbers of the same function are different.
X01	Unit Ready	Not used		
X02	Not used	Command Completion	-	
X03		Configuration Register Completion	-	
X04	Config OK AS-i 1	Configuration Error	○	
X05	AS-i Power Fail AS-i 1	AS-i Power Fail	○	
X06	Normal Operation Active AS-i 1	Normal Operation Active	○	
X07	Configuration Mode AS-i 1	Configuration Mode Active	○	
X08	Not used	Not used	×	QJ71AS92 does not have AS-i 2.
X09	Config OK AS-i 2			
X0A	AS-i Power Fail AS-i 2			
X0B	Normal Operation Active AS-i 2			
X0C	Configuration Mode AS-i 2			
X0D	Not used	Not used	-	
X0E				
X0F				
X10 to X1F	Not used	Not used	-	
Y00 to Y0F	Not used	Not used	-	
Y10	Not used	Not used	-	
Y11				
Y12	Not used	Command Execution Request	-	This signal is added for QJ71AS92.
Y13		Configuration Register Request		
Y14	Off-line Phase AS-i 1	Off-line Phase	○	
Y15	Automatic Address Assignment Function Valid AS-i 1	Auto Address Assignment Function	○	
Y16	Configuration Mode AS-i 1	Configuration Mode	○	
Y17	Protected Operation Mode AS-i 1	Protected Operation Mode	○	
Y18	Off-line Phase AS-i 2	Not used	×	QJ71AS92 does not have AS-i 2.
Y19	Automatic Address Assignment Function Valid AS-i 2			
Y1A	Configuration Mode AS-i 2			
Y1B	Protected Operation Mode AS-i 2			
Y1C	Flash ROM write	EEPROM Write	○	
Y1D	Refresh Instruction	Refresh Instruction	○	
Y1E	Not used	Not used	-	
Y1F				

5.4.2 Buffer memory

If A1SJ71AS92 AS-i 2 is replaced with B-group, I/O data storage buffer memory assignments differ from part of setup buffer memory assignments, and therefore sequence programs need to be reviewed and corrected.

For details of the buffer memory and sequence programs, refer to the "AS-i Master Module User's Manual".

○: Compatible, △: Partly changed, ×: Incompatible

Address Decimal (hexadecimal)	Description		Compat- ibility	Precautions for replacement
	A1SJ71AS92	QJ71AS92		
0000 (000H)	Input data from AS-i 1 slave 1 to 3 and part of EC Flags	(A-slaves) Input Data From Slave Address 1A-3A and part of EC Flag	○	
0001 (001H)	Input data from AS-i 1 slave 4 to 7	(A-slaves) Input Data From Slave Address 4A-7A		
0002 (002H)	Input data from AS-i 1 slave 8 to 11	(A-slaves) Input Data From Slave Address 8A-11A		
0003 (003H)	Input data from AS-i 1 slave 12 to 15	(A-slaves) Input Data From Slave Address 12A-15A		
0004 (004H)	Input data from AS-i 1 slave 16 to 19	(A-slaves) Input Data From Slave Address 16A-19A		
0005 (005H)	Input data from AS-i 1 slave 20 to 23	(A-slaves) Input Data From Slave Address 20A-23A		
0006 (006H)	Input data from AS-i 1 slave 24 to 27	(A-slaves) Input Data From Slave Address 24A-27A		
0007 (007H)	Input data from AS-i 1 slave 28 to 31	(A-slaves) Input Data From Slave Address 28A-31A		
0008 (008H)	Not used	(B-slaves) Input Data From Slave Address 1B-3B	×	A1SJ71AS92 does not support series grouping of A and B groups, and therefore cannot use the B group
0009 (009H)		(B-slaves) Input Data From Slave Address 4B-7B		
0010 (00AH)		(B-slaves) Input Data From Slave Address 8B-11B		
0011 (00BH)		(B-slaves) Input Data From Slave Address 12B-15B		
0012 (00CH)		(B-slaves) Input Data From Slave Address 16B-19B		
0013 (00DH)		(B-slaves) Input Data From Slave Address 20B-23B		
0014 (00EH)		(B-slaves) Input Data From Slave Address 24B-27B		
0015 (00FH)		(B-slaves) Input Data From Slave Address 28B-31B		
0016 (010H)	EC Flags AS-i 1	EC Flags	○	
0017 (011H) to 0018 (012H)	LDS AS-i 1	(A-slaves) List of Detected Slaves (LDS)	○	
0019 (013H) to 0020 (014H)	Not used	(B-slaves) List of Detected Slaves (LDS)	×	A1SJ71AS92 does not support series grouping of A and B groups, and therefore cannot use the B group
0021 (015H) to 0022 (016H)	LAS AS-i 1	(A-slaves) List of Active Slaves (LAS)	○	
0023 (017H) to 0024 (018H)	Not used	(B-slaves) List of Active Slaves (LAS)	×	A1SJ71AS92 does not support series grouping of A and B groups, and therefore cannot use the B group
0025 (019H) to 0026 (01AH)		(A-slaves) List of Projected Slaves (LPS (For Read))	○	
0027 (01BH) to 0028 (01CH)		(B-slaves) List of Projected Slaves (LPS (For Read))	×	A1SJ71AS92 does not support series grouping of A and B groups, and therefore cannot use the B group
0029 (01DH) to 0030 (01EH)		List of slaves with configuration differences AS-i 1	(A-slaves) List of slaves that differ from settings	○

Address Decimal (hexadecimal)	Description		Compat- ibility	Precautions for replacement
	A1SJ71AS92	QJ71AS92		
0031 (01FH) to 0032 (020H)	Not used	(B-slaves) List of slaves that differ from settings	×	A1SJ71AS92 does not support series grouping of A and B groups, and therefore cannot use the B group
0033 (021H) to 0034 (022H)		(A-slaves) Error Slave List	-	This function is added to QJ71AS92.
0035 (023H) to 0036 (024H)		(B-slaves) Error Slave List		
0037 (025H) to 0041 (029H)	Command Buffer AS-i 1: <Result>	Command Buffer <Result>	○	
0042 (02AH) to 0047 (02FH)	Not used	Not used	-	
0048 (030H)	Output data from AS-i 1 slave 1 to 3	(A-slaves) Output Data To Slave Address 1A-3A	○	
0049 (031H)	Output data from AS-i 1 slave 4 to 7	(A-slaves) Output Data To Slave Address 4A-7A		
0050 (032H)	Output data from AS-i 1 slave 8 to 11	(A-slaves) Output Data To Slave Address 8A-11A		
0051 (033H)	Output data from AS-i 1 slave 12 to 15	(A-slaves) Output Data To Slave Address 12A-15A		
0052 (034H)	Output data from AS-i 1 slave 16 to 19	(A-slaves) Output Data To Slave Address 16A-19A		
0053 (035H)	Output data from AS-i 1 slave 20 to 23	(A-slaves) Output Data To Slave Address 20A-23A		
0054 (036H)	Output data from AS-i 1 slave 24 to 27	(A-slaves) Output Data To Slave Address 24A-27A		
0055 (037H)	Output data from AS-i 1 slave 28 to 31	(A-slaves) Output Data To Slave Address 28A-31A		
0056 (038H)	Not used	(B-slaves) Output Data To Slave Address 1B-3B		
0057 (039H)		(B-slaves) Output Data To Slave Address 4B-7B		
0058 (03AH)		(B-slaves) Output Data To Slave Address 8B-11B		
0059 (03BH)		(B-slaves) Output Data To Slave Address 12B-15B		
0060 (03CH)		(B-slaves) Output Data To Slave Address 16B-19B		
0061 (03DH)		(B-slaves) Output Data To Slave Address 20B-23B		
0062 (03EH)		(B-slaves) Output Data To Slave Address 24B-27B		
0063 (03FH)		(B-slaves) Output Data To Slave Address 28B-31B		
0064 (040H) to 0072 (048H)	Not used	Not used	-	
0073 (049H) to 0074 (04AH)	LPS AS-i 1 (For Write)	(A-slaves) List of Projected Slaves (LPS (For Write))	○	
0075 (04BH) to 0076 (04CH)	Not used	(B-slaves) List of Projected Slaves (LPS (For Write))	×	A1SJ71AS92 does not support series grouping of A and B groups, and therefore cannot use the B group
0077 (04DH) to 0084 (054H)		Not used	-	
0085 (055H)	Command Buffer AS-i 1: <Command>	Command Buffer: <Request (Command)>	○	
0086 (056H) to 0089 (059H)		Command Buffer: <Request (data word 0 to 3 (Command))>		

Address Decimal (hexadecimal)	Description		Compat- ibility	Precautions for replacement
	A1SJ71AS92	QJ71AS92		
0090 (05AH) to 0095 (05FH)	Not used		-	
0096 (060H)	Input data from AS-i 2 slave 1 to 3 and part of EC Flags			
0097 (061H)	Input data from AS-i 2 slave 4 to 7			
0098 (062H)	Input data from AS-i 2 slave 8 to 11			
0099 (063H)	Input data from AS-i 2 slave 12 to 15			
0100 (064H)	Input data from AS-i 2 slave 16 to 19			
0101 (065H)	Input data from AS-i 2 slave 20 to 23			
0102 (066H)	Input data from AS-i 2 slave 24 to 27			
0103 (067H)	Input data from AS-i 2 slave 28 to 31			
0104 (068H) to 0111 (06FH)	Not used			
0112 (070H)	EC Flags AS-i 2			
0113 (071H) to 0114 (072H)	LDS AS-i 2			
0115 (073H) to 0116 (074H)	Not used			
0117 (075H) to 0118 (076H)	LAS AS-i 2			
0119 (077H) to 0120 (078H)	Not used			
0121 (079H) to 0122 (07AH)	LPS AS-i 2			
0123 (07BH) to 0124 (07CH)	Not used			
0125 (07DH) to 0126 (07EH)	List of slaves with configuration differences AS-i 2	Not used	x	The B group cannot be used if an existing Ver.2.04-compatible I/O slave is used. The master module needs to be examined for the replacement to 2 modules.
0127 (07FH) to 0132 (084H)	Not used			
0133 (085H) to 0137 (089H)	Command Buffer AS-i 2: <Result>			
0138 (08AH) to 0143 (08FH)	Not used			
0144 (090H)	Output data from AS-i 2 slave 1 to 3			
0145 (091H)	Output data from AS-i 2 slave 4 to 7			
0146 (092H)	Output data from AS-i 2 slave 8 to 11			
0147 (093H)	Output data from AS-i 2 slave 12 to 15			
0148 (094H)	Output data from AS-i 2 slave 16 to 19			
0149 (095H)	Output data from AS-i 2 slave 20 to 23			
0150 (096H)	Output data from AS-i 2 slave 24 to 27			
0151 (097H)	Output data from AS-i 2 slave 28 to 31			
0152 (098H) to 0168 (0A8H)	Not used			
0169 (0A9H) to 0170 (0AAH)	LPS AS-i 2			
0171 (0ABH) to 0180 (0B4H)	Not used			
0181 (0B5H) to 0185 (0B9H)	Command Buffer AS-i 2: <Command>			
0186 (0BAH)	Not used			
0187 (0BBH) to 0191 (0BFH)		Not used	-	
0192 (0C0H) to 0197 (0C5H)		Current Error Code, Error Code History 1-5		
0198 (0C6H)		EEPROM Write Status		
199 (0C7H) to 207 (0CFH)		Not used		
208 (0D0H) to 209 (0D1H)		(A-slaves) List of Peripheral Faults (LPF)		
210 (0D2H) to 211 (0D3H)		(B-slaves) List of Peripheral Faults (LPF)		
212 (0D4H) to 223 (0DFH)		Not used		
224 (0E0H) to 351 (15FH)	(Not-used area)	Analog Input Data (Slave Address 1-31)		
352 (160H) to 479 (1DFH)		Analog Output Data (Slave Address 1-31)		
480 (1E0H) to 511 (1FFH)		(A-slaves) Number of I/O Points		
512 (200H) to 543 (21FH)		(B-slaves) Number of I/O Points		
544 (220H) to 767 (2FFH)		Not used		
768 (300H) to 877 (36DH)		Extended Command Buffer <Result>		
878 (36EH) to 1023 (3FFH)		Not used		
1024 (400H) to 1133 (46DH)		Extended Command Buffer <Request(Data)>		
1134 (46EH) to 2047 (7FFH)		Not used		
			-	This function is added to QJ71AS92.

5.5 Program Diversion

If the sequence program of the existing AnS series AS-i master module is diverted to the Q series AS-i master module, the sequence program needs to be reviewed and corrected. Review and correct the program as follows.

(1) I/O signals

Some different I/O signals are used and therefore the program needs to be reviewed and corrected in this respect.

Correct the program by referring to Section 5.4 or the "AS-i Master Module User's Manual".

(2) Existing AS-i 2 program

Existing AS-i 2 cannot be replaced with the B group and therefore the master module needs to be replaced with two modules.

For the program of existing AS-i 2, create a new program as one for the A group of the new master module.

(3) Example of replacement

(a) Example of diversion of existing AS-i 1 program to one for the A group

1) Example of existing configuration

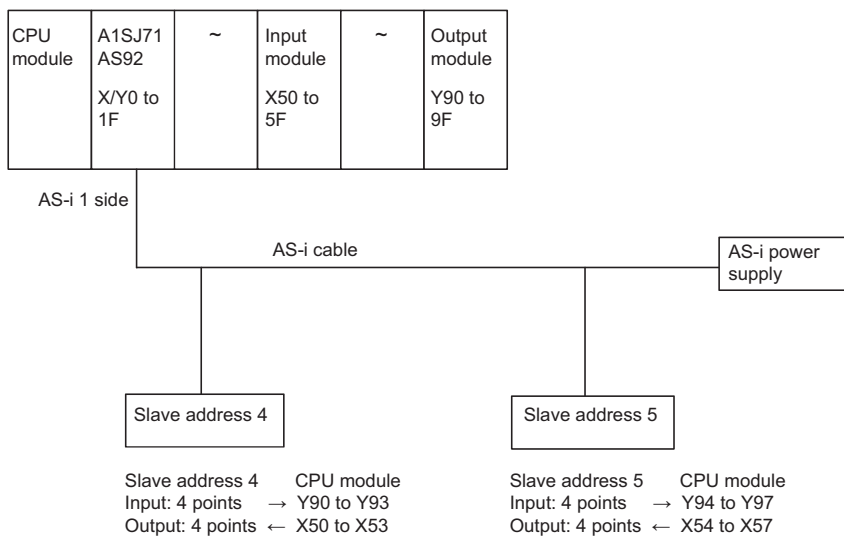

2) Example of configuration after replacement

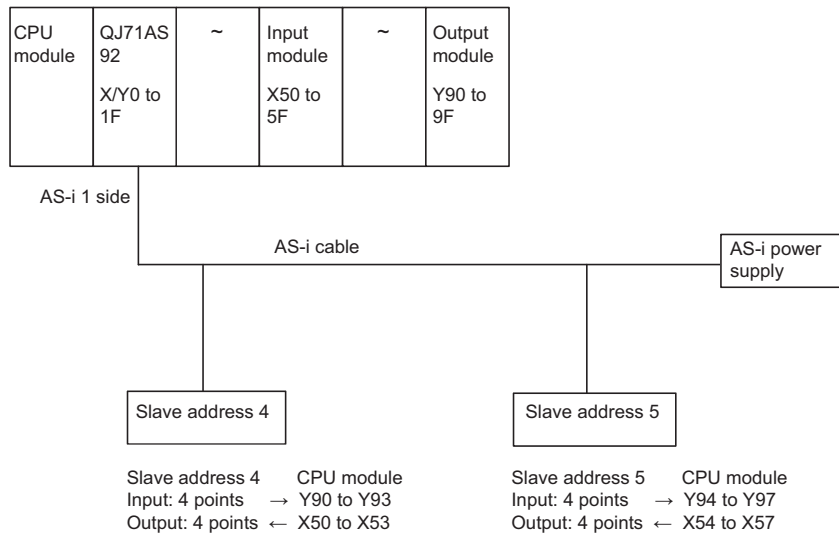

(b) Example of correction of existing program

1) Example of existing A1S71AS92 program

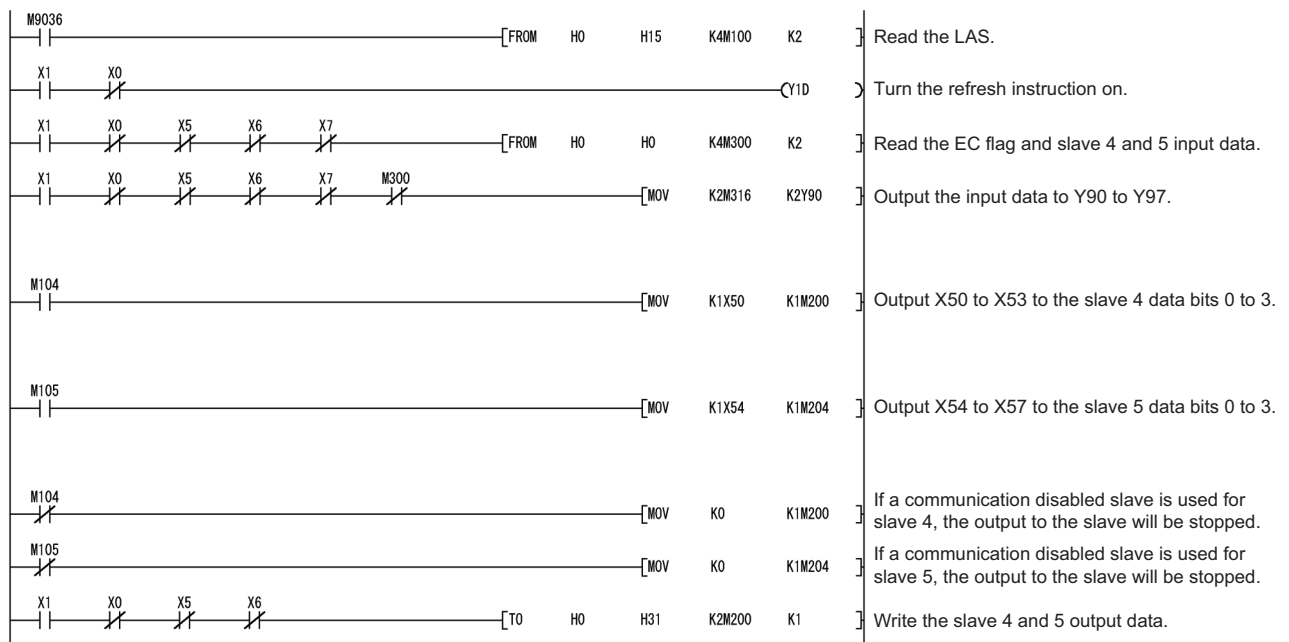

• Explanation of devices

X0	: Watchdog Timer Error (OFF when normal)
X1	: Module Ready (ON when normal)
X5	: AS-i 1 AS-i Power Fail (OFF when normal)
X6	: AS-i 1 normal operation check (OFF in normal operation)
X7	: AS-i 1 configuration mode (OFF in other than configuration mode)
M104	: ON when slave number 4 is in the communication enabled state
M105	: ON when slave number 5 is in the communication enabled state
M200 to M203	: Output data to slave number 4
M204 to M207	: Output data to slave number 5
M300	: AS-i Config_OK (OFF when normal)
M316 to M319	: Input data from slave number 4
M320 to M323	: Input data from slave number 5

6 MULTIDROP LINK MODULE REPLACEMENT

6.1 List of Multidrop Link Modules to be Replaced

A/AnS series model		Q series replacement model	
Product name	Model	Model name	Remarks (restrictions)
Master station/local station module	AJ71C22(S1)	No replacement module	Consider to replace the current link to CC-Link with the existing module configuration, or to keep the multidrop link by mounting the existing module to the QA (1S) extension base unit.
Computer link module (When set to the multidrop link function)	AJ71UC24		
	A1SJ71UC24-R4		
Computer link module (When set to the multidrop link function)	A0J2-C214(S1)	No replacement module	Consider to replace the current link to CC-Link with the existing module configuration. The A0J2(H) series module cannot be mounted on the QA(1S) extension base unit and therefore cannot be replaced with the multidrop link function retained.
Remote I/O station module	A0J2C25	No replacement module	Consider to replace the current link to CC-Link. Replacing an I/O module connected to A0J2C25 by using the renewal tool (*1) for A0J2 can reduce man-hours such as eliminating the need for changing the wiring.
Products from partner manufacturers (Replaceable with CC-Link)	- (Such as manifold solenoid valve)	No replacement module	Consider to replace the current link to CC-Link. If there is a replacement module, contact the partner manufacturer for module selection and specifications comparison.
Products from partner manufacturers (Difficult to be replaced with CC-Link)	-	No replacement module	Consider to keep the existing multidrop link by mounting the existing module to the QA (1S) extension base unit.

*1 Manufactured by Mitsubishi Electric System & Service Co., Ltd.

6.2 Replacement Configuration Examples

This section describes some examples of replacement configurations when replacing the multidrop link function with CC-Link or continuously using the multidrop link by taking advantage of the QA(1S) extension base unit.

(1) When the remote and local stations are all replaceable with CC-Link

Replace the remote and local stations with CC-Link. The following shows a configuration example.

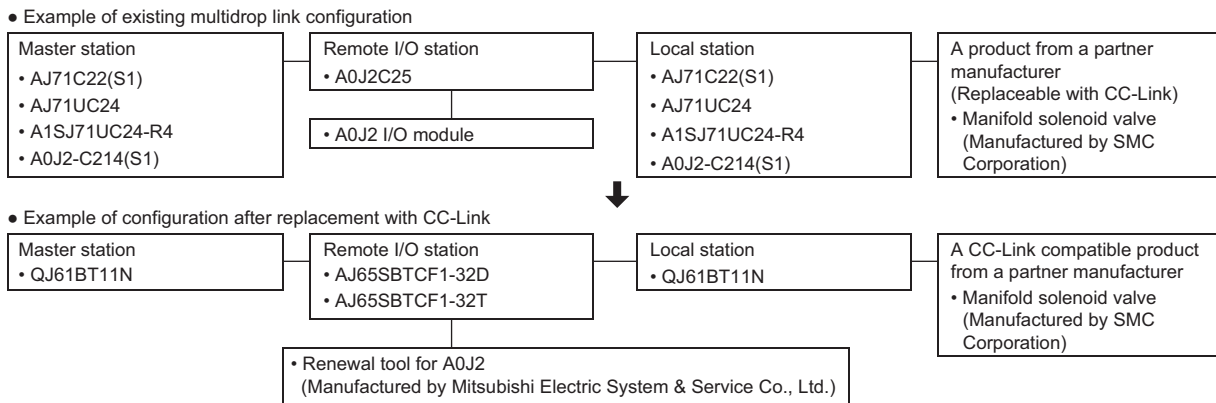

(2) When the remote and local stations have some modules which are difficult to be replaced with CC-Link

Configure two networks. If the remote and local stations are replaceable with CC-Link, replace them with CC-Link. If products from partner manufacturers are difficult to be replaced with CC-Link, mount the modules of the existing master station on the QA(1S) extension base unit holding multidrop link to use the products continuously. The following shows a configuration example.

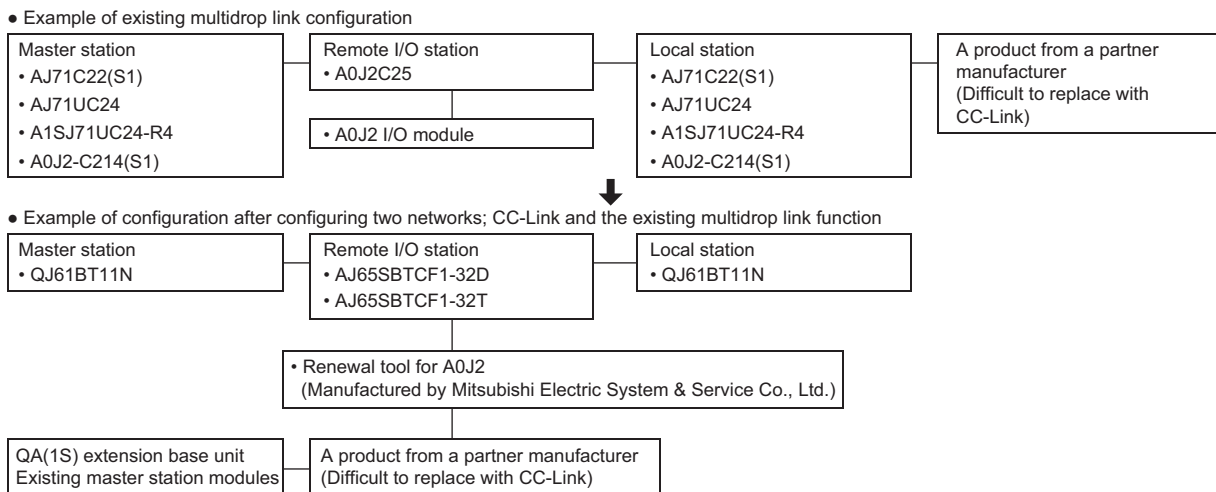

(3) When all modules of the remote and local stations are difficult to be replaced with CC-Link

Mount the modules of the existing master station on the QA(1S) extension base unit holding multidrop link to use the products continuously. The following shows a configuration example.

- Example of existing multidrop link configuration

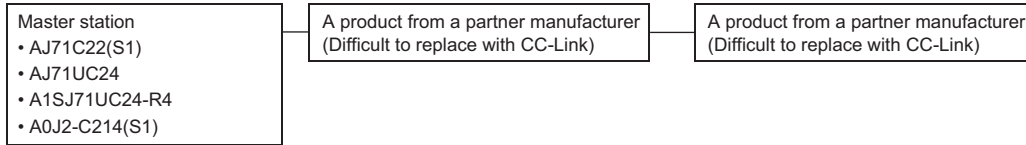

- Example of configuration using the existing multidrop link function continuously

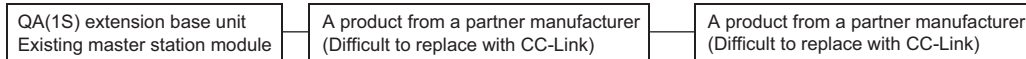

☒ Point

- (1) The I/O modules of remote station A0J2C25 are A0J2 I/O modules.
Using the renewal tool for A0J2, Mitsubishi Electric System & Service Co., Ltd., for replacement to CC-Link, can eliminate the need for mounting hole drilling for the replacement module and enables diversion of I/O external wiring, and thus can reduce replacement man-hours.
For more information, refer to the "Transition from MELSECNET/MINI-S3, A2C (I/O) to CC-Link Handbook".
- (2) For products from partner manufacturers, ask the relevant partner manufacturers whether they have replacement products having the equivalent functions and specifications with regard to CC-Link.
For information on where to ask, check the home page of "CC-Link Partner Association".
- (3) Some products from partner manufacturers may be difficult to be replaced with CC-Link due to their unique functions. Keep using these products under control of the existing multidrop link function by mounting the existing master module on the QA(1S) extension base unit.
Note that when A0J2-C214(S1) is used with CPU module A0J2(H)CPU, the QA(1S) extension base unit cannot be used.
Note also that new purchases of existing modules are not possible and that the repair acceptance period cannot be extended.

7 MODBUS® MODULE REPLACEMENT

7.1 List of MODBUS® Modules to be Replaced

A/AnS series model	Q series replacement model	Remarks
AJ71UC24-S2	QJ71MB91	RS-232: 1ch, RS-422/485: 1ch
A1SJ71UC24-R2-S2		QJ71MB91 supports the operations of both master and slave stations.
A1SJ71UC24-R4-S2		

7.2 Performance Specifications Comparison

7.2.1 Module performance comparison

○: Compatible △: Partly changed ×: Incompatible

Item			Specifications		Compat- ibility	Precautions for replacement					
			A/AnS series	Q series							
			AJ71UC24-S2 A1SJ71UC24-R2-S2 A1SJ71UC24-R4-S2	QJ71MB91							
Specifications	Number of interfaces	RS-232	RS-232 compliant (D-Sub25P) AJ71UC24-S2: 1ch RS-232 compliant (D-Sub9P) A1SJ71UC24-R2-S2: 1ch A1SJ71UC24-R4-S2: None	RS-232 compliant (D-Sub9P) QJ71MB91: 1ch	△	Replacement from AJ71UC24-S2 requires changing the connector.					
		RS-422/485	RS-422/485 compliant AJ71UC24-S2: 1ch A1SJ71UC24-R2-S2: None A1SJ71UC24-R4-S2: 1ch	RS-422/485 compliant (Two-piece terminal block) QJ71MB91: 1ch	△	Wiring needs to be changed.					
	Transmission speed		300 to 19,200bps (Selection by switch)	300 to 115,200bps (2 channel total)	○						
	Transmission distance (Overall cable distance)	RS-232	15 m maximum	15 m maximum	○						
		RS-422/485	500 m maximum (overall cable distance)	1200 m maximum (overall cable distance)	○						
Master function	Automatic communication	Communication enabled	(Master function not supported)	Max. 32 per channel	-	QJ71MB91 supports the operation of the master station.					
		Number of slave stations		7 functions							
		Function (for transmission)		4k words							
		Input area size		4k words							
	Communication by dedicated instructions (MBRW instruction, MBREQ instruction)	Number of simultaneous executable instructions		1 instruction per channel							
		Function (for transmission)		MBRW instruction: 9 functions MBREQ instruction: 19 functions							
		Input area size		Max. 253 bytes per instruction							
		Output area size		Max. 253 bytes per instruction							
		Slave function		Automatic response function			Function (for receiving)	13 functions	17 functions	○	Functions have been improved.
				MODBUS® device size			Coil	10,000 points	64k points		
Input	-		64k points								
Input register	-		64k points								
Holding register	10,000 points		64k points								
Extended file register	8k points	Max 4,086k points									
Number of simultaneously receivable request messages		1 request per channel	1 request per channel	○							
Station No.		AJ71UC24-S2: 1 to 99 A1SJ71UC24-R2-S2: - A1SJ71UC24-R4-S2: 1 to 99	1 to 247	○							
5VDC internal current consumption			AJ71UC24-S2: 1.40A A1SJ71UC24-R2-S2: 0.10A A1SJ71UC24-R4-S2: 0.10A	0.31A	△	The current capacity needs to be reviewed because current consumption will be increased.					
Weight			AJ71UC24-S2: 0.63kg A1SJ71UC24-R2-S2: 0.22kg A1SJ71UC24-R4-S2: 0.25kg	0.20kg	○						

7.2.2 Cable specification comparison

○: Compatible △: Partly changed ×: Incompatible

Item	Specifications		Compat- ibility	Precautions for replacement																		
	A/AnS series	Q series																				
	AJ71UC24-S2 A1SJ71UC24-R2-S2 A1SJ71UC24-R4-S2	QJ71MB91																				
RS-232	Cable	Use cables compliant with the RS-232C standard.*1		○																		
	Cable length	Max. 15m		○																		
	External wiring compatible connector (Module side of connection cable)	AJ71UC24-S2: D-Sub 25P A1SJ71UC24-R2-S2: D-Sub 9P (Male, screwing type) (Mating screw M2.6)	D-Sub 9P (Male, screwing type) (Mating screw M2.6)	△	Replacement from AJ71UC24-S2 requires changing the connector.																	
RS-422/485	Cable	<table border="1"> <thead> <tr> <th>Item</th> <th>Description</th> </tr> </thead> <tbody> <tr> <td>Cable type</td> <td>Shielded cable</td> </tr> <tr> <td>Number of twists</td> <td>3P</td> </tr> <tr> <td>Conductor resistance (20°C)</td> <td>88.0Ω/km or less</td> </tr> <tr> <td>Insulation resistance</td> <td>10000MΩ·km or more</td> </tr> <tr> <td>Withstand voltage</td> <td>500VDC for 1 minute</td> </tr> <tr> <td>Capacitance (1kHz)</td> <td>Average 60nF/km or less</td> </tr> <tr> <td>Characteristic impedance (100kHz)</td> <td>110±10Ω</td> </tr> </tbody> </table>		Item	Description	Cable type	Shielded cable	Number of twists	3P	Conductor resistance (20°C)	88.0Ω/km or less	Insulation resistance	10000MΩ·km or more	Withstand voltage	500VDC for 1 minute	Capacitance (1kHz)	Average 60nF/km or less	Characteristic impedance (100kHz)	110±10Ω		○	
		Item	Description																			
		Cable type	Shielded cable																			
		Number of twists	3P																			
		Conductor resistance (20°C)	88.0Ω/km or less																			
Insulation resistance		10000MΩ·km or more																				
Withstand voltage		500VDC for 1 minute																				
Capacitance (1kHz)	Average 60nF/km or less																					
Characteristic impedance (100kHz)	110±10Ω																					
Cable length	Max. 500m (overall cable distance)	Max. 1,200m (overall cable distance)	○																			
External wiring compatible connector (Module side of connection cable)	Connected to terminal block		○	Refer to the manual for the connection method.																		

*1 The recommended cables of RS-232 and RS-422/485 are described in the manual of the Q Series MODBUS® Interface Module.

7.3 Function Comparison

○: Function available △: Partly restricted -: Function unavailable

Function		Description	A/AnS	Q	Precautions for replacement
Master function	Automatic communication	Automatically issues device read/write request messages from the master (QJ71MB91) to a MODBUS® compatible slave device.	-	○	The master function has been added to QJ71MB91.
	Communication by dedicated instructions	Allows reading/writing of MODBUS® devices at any timing with a sequence program.	-	○	
Slave function	Automatic response function	Automatically performs the processing corresponding to the function code in the request message received from the master, and automatically sends a response message.	○	○	
	MODBUS® device assignment function	Automatically converts access from the slave to a MODBUS® device into access to a QCPU device. Users can assign any access destination. This allows direct access from the MODBUS® compatible master device to the programmable controller CPU device memory.	○	○	
	Link operation function	This function allows the master connected to CH1 (RS-232) communicate with several slave stations connected to CH2 (RS-422/485). If the link operation function is used, a RS-232 interface (1-to-1 communication) MODBUS® master device can communicate with several MODBUS® slave devices.	△	○	Among the modules of the A/AnS series, only AJ71UC24-S2 has the link operation function.
Status check function		Checks the operations of the module itself and the send/receive functions.			
	Hardware test	Tests the RAM and ROM of the QJ71MB91.	-	○	
	Self-loopback test	This test checks the send/receive function of the module and communications with the programmable controller CPU.	○	○	
Various settings using utility package (GX Configurator-MB)		By using the utility package (GX Configurator-MB), parameters such as automatic communication parameters or MODBUS® device assignment parameters can be set on-screen, and status monitoring is available. This makes the parameter setting and status monitoring easier.	-	○	No utility package is compatible with the A/AnS series. Set parameters using the sequence program.
Various settings using programming tool (GX Works2)		By using the programming tool (GX Works2), parameters such as switch setting, automatic communication parameters, or MODBUS® device assignment parameters. This makes the parameter setting easier.	-	○	The A/AnS series is not compatible with GX Works2. Set parameters using the sequence program.

7.4 Switch Settings Comparison

(1) Comparison between AJ71UC24-S2 and QJ71MB91

○: Compatible △: Partly changed ×: Incompatible

Switch name	Description			Compat- ibility	Precautions for replacement	
	A series		Q series			
	AJ71UC24-S2		QJ71MB91			
Mode Setting Switch	Used to set the mode in each interface depending on the data communication function used.					
	Switch	RS-232C	RS-422/485	*1	△	Set the mode using GX Developer PLC parameter "Intelligent function module switch setting" or GX Works2 project "Intelligent function module".
	0	MODBUS® protocol	Unusable			
	1	Unusable	MODBUS® protocol			
	2	MODBUS® protocol ↔ MODBUS® protocol				
	3 to E	Unusable				
F	For self-loopback test					
Station No. setting switch	Set the station number of the module used for communication.					
	01 to 99		Master function: 00H Slave function: 1H to F7H (1 to 247)*1	△	Set the switch using GX Developer PLC parameter "Intelligent function module switch setting" or GX Works2 project "Intelligent function module".	
Transmission specifications setting switch	SW11	Main channel setting*2	Set the target interface for send processing and receive processing when 2 is set in the mode setting.	*1	△	Set the switch using GX Developer PLC parameter "Intelligent function module switch setting" or GX Works2 project "Intelligent function module".
	SW12	Character code setting*3	Set the character code of the data to be sent or received. (RTU: 8 bits/ASCII: 7 bits)			
	SW13 SW14 SW15	Transmission speed setting	Set the transmission speed at which data is sent or received. (300 to 19,200bps)			
	SW16	Parity bit present/absent setting	Specify whether to enable the parity bit for the data to be sent or received. (Enable/disable)			
	SW17	Even/odd parity setting	Set the type of the parity bit to be added to the data to be sent or received. (Even/Odd)			
	SW18	Stop bit setting	Set the stop bit length of the data to be sent or received. (2 stop bits/1 stop bit)			
	SW21	Not used	-			
	SW22	Write during RUN enabled/disabled	Specify whether to enable/disable online program change during data communication. (Enable/disable)			
	SW23	Not used	(Always ON)			
	SW24	Not used	-			

*1 Refer to the point.

*2 In QJ71MB91, the RS-232 side is set to the main channel by performing link operation setting.

*3 In QJ71MB91, it is referred to as "frame mode".

(2) Comparison between A1SJ71UC24-R2-S2/A1SJ71-R4-S2 and QJ71MB91

○: Function available △: Partly restricted -: Function unavailable

Switch name	Description		Compat- ibility	Precautions for replacement																										
	AnS series				Q series																									
	A1SJ71UC24-R2-S2 A1SJ71UC24-R4-S2				QJ71MB91																									
Mode setting switch	Used to set the mode in each interface depending on the data communication function used.																													
	<ul style="list-style-type: none"> ● A1SJ71UC24-R2-S2 <table border="1"> <tr> <th>Switch</th> <th>RS-232C</th> <th>RS-422/485</th> </tr> <tr> <td>0</td> <td>MODBUS® protocol</td> <td>Unusable</td> </tr> <tr> <td>1 to E</td> <td colspan="2">Not available</td> </tr> <tr> <td>F</td> <td colspan="2">For self-loopback test</td> </tr> </table> ● A1SJ71UC24-R2-S2 <table border="1"> <tr> <th>Switch</th> <th>RS-232C</th> <th>RS-422/485</th> </tr> <tr> <td>0</td> <td colspan="2">Not available</td> </tr> <tr> <td>1</td> <td>-</td> <td>MODBUS® protocol</td> </tr> <tr> <td>2 to E</td> <td colspan="2">Not available</td> </tr> <tr> <td>F</td> <td colspan="2">For self-loopback test</td> </tr> </table> 		Switch	RS-232C	RS-422/485	0	MODBUS® protocol	Unusable	1 to E	Not available		F	For self-loopback test		Switch	RS-232C	RS-422/485	0	Not available		1	-	MODBUS® protocol	2 to E	Not available		F	For self-loopback test		*1
Switch	RS-232C	RS-422/485																												
0	MODBUS® protocol	Unusable																												
1 to E	Not available																													
F	For self-loopback test																													
Switch	RS-232C	RS-422/485																												
0	Not available																													
1	-	MODBUS® protocol																												
2 to E	Not available																													
F	For self-loopback test																													
Station No. setting switch	Set the station number of the module used for communication.																													
	<ul style="list-style-type: none"> ● A1SJ71UC24-R2-S2: - (No station number setting) ● A1SJ71UC24-R4-S2: 01 to 99 		- (Master function: 00H Slave function: 1H to F7H (1 to 247))*1	△ Set the switch using GX Developer PLC parameter "Intelligent function module switch setting" or GX Works2 project "Intelligent function module".																										
Transmission specifications setting switch	SW01	Not used	-																											
	SW02	Not used	(Always ON)																											
	SW03	Not used	-																											
	SW04	Online program change enable/disable setting	Specify whether to enable/disable online program change during data communication. (Enable/disable)																											
	SW05 SW06 SW07	Transmission speed setting	Set the transmission speed at which data is sent or received. (300 to 19,200bps)																											
	SW08	Character code setting*2	Set the character code of the data to be sent or received. (RTU: 8 bits/ASCII: 7 bits)	*1	△ Set the switch using GX Developer PLC parameter "Intelligent function module switch setting" or GX Works2 project "Intelligent function module".																									
	SW09	Parity bit present/absent setting	Specify whether to enable the parity bit for the data to be sent or received. (Enable/disable)																											
	SW10	Even/odd parity setting	Set the type of the parity bit to be added to the data to be sent or received. (Even/Odd)																											
	SW11	Stop bit setting	Set the stop bit length of the data to be sent or received. (2 bits/1 bit)																											
	SW12	Not used	-																											

*1 Refer to the point.

*2 In QJ71MB91, it is referred to as "frame mode".

☒ Point

(1) Example of GX Developer intelligent function module switch settings

(a) Mode setting example

Set value		Operation mode	
Switch 1	Switch 3	CH1	CH2
0000H	0000H	Master function	Master function
0000H	0001H	Master function	Slave function
0001H	0000H	Slave function	Master function
0001H	0001H	Slave function	Slave function
0002H	0002H	Link operation (slave function)	
000DH	000DH	Hardware test	
000EH	000DH	Self-loopback test	-
000DH	000EH	-	Self-loopback test
000EH	000EH	Self-loopback test	Self-loopback test

(b) Station No. setting example

Switch 5	Upper byte	Lower byte
	Channel 2 station number	Channel 1 station number

(c) Communication speed/transmission settings

Switch 2 (Channel 1)	Upper byte	Lower byte
Switch 4 (Channel 2)	Communication speed setting	Transmission setting

(2) GX Works2 intelligent function module setting window

Item	CH1	CH2
Mode setting	Master Function	Master Function
MODBUS device assignment parameter starting method	Default Parameter	-
Transmission Setting		
Data bit	8	8
Parity bit	Exist	Exist
Even/odd	Even	Even
Stop bit	1	1
Frame mode	RTU Mode	RTU Mode
Online change	Disable	Disable
Communication speed setting	19200 bps	19200 bps
Station No. setting	0	0

* For details of switch setting, refer to the "MODBUS® Interface Module User's Manual".

7.5 Program Comparison

7.5.1 I/O signals

The A/AnS series MODBUS® interface module and the Q series MODBUS® interface module are not compatible with regard to the assignments of I/O signals. Review and correct the sequence program as follows.

Signal name			
Input signal	AJ71UC24-S2/A1SJ71UC24-R2-S2/A1SJ71UC24-R4-S2	Input signal	QJ71MB91
X00	RS-232C communication error (* Cannot be used with A1SJ71UC24-R4-S2)	X00	Module READY ON: Accessible OFF: Inaccessible
X01	RS-422/485 communication error (* Cannot be used with A1SJ71UC24-R2-S2)	X01	Use prohibited
X02	Unusable	X02	
X03		X03	
X04		X04	CH1 Automatic communication parameter setting, normally completed ON: Normally completed OFF: -
X05	Unusable	X05	CH1 Automatic communication parameter setting, error completed ON: Error completed OFF: -
X06		X06	CH1 Automatic communication operation status ON: Operating OFF: Stopped
X07		Ready signal	X07
X08	Parameter error	X08	MODBUS® device assignment parameter setting, normally completed ON: Normally completed OFF: -
X09	Unusable	X09	MODBUS® device assignment parameter setting, error completed ON: Error completed OFF: -
X0A		X0A	MODBUS® device assignment parameter setting existence ON: Parameters set OFF: No parameters set
X0B		X0B	Use prohibited
X0C		X0C	CH2 Automatic communication parameter setting, normally completed ON: Normally completed OFF: -
X0D	Watchdog timer error	X0D	CH2 Automatic communication parameter setting, error completed ON: Error completed OFF: -
X0E	Unusable	X0E	CH2 Automatic communication operation status ON: Operating OFF: Stopped
X0F		X0F	CH2 Automatic communication error status ON: Error occurred OFF: No error

Signal name			
Input signal	AJ71UC24-S2/A1SJ71UC24-R2-S2/A1SJ71UC24-R4-S2	Input signal	QJ71MB91
X10	Not used (unusable)	X10	Intelligent function module switch setting change status ON: Setting being changed OFF: Setting not changed
X11		X11	Use prohibited
X12		X12	
X13		X13	
X14		X14	
X15		X15	
X16		X16	
X17		X17	
X18		X18	
X19		X19	
X1A		X1A	
X1B		X1B	CH Common/CH1 Error ON: Error occurred OFF: No error
X1C		X1C	CH2 Error ON: Error occurred OFF: No error
X1D		X1D	Use prohibited
X1E		X1E	
X1F		X1F	Watch dog timer error ON: Module error occurred OFF: Module operating normally

Signal name			
Output signal	AJ71UC24-S2/A1SJ71UC24-R2-S2/A1SJ71UC24-R4-S2	Output signal	QJ71MB91
Y00	Not used (unusable)	Y00	Use prohibited
Y01		Y01	
Y02		Y02	
Y03		Y03	CH1 Automatic communication parameter setting request/ automatic communication start request ON: Being requested OFF: Not requested
Y04		Y04	
Y05		Y05	Use prohibited
Y06		Y06	CH1 Automatic communication stop request ON: Being requested OFF: Not requested
Y07		Y07	Use prohibited
Y08		Y08	MODBUS® device assignment parameter setting request ON: Being requested OFF: Not requested
Y09		Y09	Use prohibited
Y0A		Y0A	
Y0B		Y0B	
Y0C		Y0C	CH2 Automatic communication parameter setting request/ automatic communication start request ON: Being requested OFF: Not requested
Y0D		Y0D	Use prohibited
Y0E		Y0E	CH2 Automatic communication stop request ON: Being requested OFF: Not requested
Y0F		Y0F	Use prohibited
Y10	RS-232C communication error cancel (* Cannot be used with A1SJ71UC24-R4-S2)	Y10	
Y11	RS-422/485 communication error cancel (* Cannot be used with A1SJ71UC24-R2-S2)	Y11	
Y12	Unusable	Y12	
Y13		Y13	
Y14		Y14	
Y15		Y15	
Y16	Y16	Parameter change request	
Y17	Y17		
Y18	Unusable	Y18	
Y19		Y19	
Y1A		Y1A	CH2 Error clear request ON: Being requested OFF: Not requested
Y1B		Y1B	
Y1C		Y1C	Use prohibited
Y1D		Y1D	
Y1E		Y1E	
Y1F		Y1F	Y1F

7.5.2 Buffer memory

The A/AnS series MODBUS® interface module and the Q series MODBUS® interface module are not compatible with regard to the assignments of buffer memory. Review and correct the sequence program as follows.

		Description			
Address Hexadecimal (decimal)	AJ71UC24-S2/A1SJ71UC24-R2-S2/ A1SJ71UC24-R4-S2	Address Hexadecimal (decimal)	QJ71MB91		
	Name		Application	Name	
0000H (0)	Mode setting status storage area	0000H to 0001H (0 to 1)	System area (use prohibited)		
0001H (1)	Station number setting status storage area				
0002H (2)	RS-232C error response code storage area	0002H (2)	Status storage area	Error code	CH1 side error response code storage area
0003H (3)	RS-232C error detail code storage area	0003H (3)			System area (use prohibited)
0004H (4)	RS-422/485 error response code storage area	0004H (4)			CH2 side error response code storage area
0005H (5)	RS-422/485 detail response code storage area	0005H (5)		System area (use prohibited)	
0006H (6)	RS-232C error LED indicator status storage area	0006H (6)		Detailed LED status	CH1 side detailed LED status storage area
0007H (7)	RS-422/485 error LED indicator status storage area	0007H (7)			CH2 side detailed LED status storage area
0008H (8)	RS-232C error LED OFF request storage area	0008H (8)		Detailed LED clear request	CH1 side detailed LED clear request storage area
0009H (9)	RS-422/485 error LED OFF request storage area	0009H (9)	CH2 side detailed LED clear request storage area		
000AH (10)	Error status read device No. storage area	Device code	Setting area	Setting error status read device	Device code
000BH (11)		Device No.			000BH (11)
000CH (12)	Optional function (computer link function) function code change request storage area	000CH (12)	System area (use prohibited)		
000DH to 000FH (13 to 15)	Vacant area	000DH (13)	CPU response monitoring timer value Set time = set value × 500ms		
		000EH (14)	Access target (when mounted to MELSECNET/H remote I/O station)		
		000FH (15)	Allocated error status area		

Description						
Address Hexadecimal (decimal)	AJ71UC24-S2/A1SJ71UC24-R2-S2/ A1SJ71UC24-R4-S2	Address Hexadecimal (decimal)	QJ71MB91			
	Name		Application	Name		
0010H to 0023H (16 to 35)	Allocation for window for coils	0010H to 01FFH (16 to 511)	System area (use prohibited)			
0024H to 002FH (36 to 47)	Vacant area					
0030H to 0043H (48 to 67)	Allocation for window for latch registers					
0044H to 0DEFH (68 to 3551)	User area	0200H to 0201H (512 to 513)	Automatic communication parameter	CH1 Automatic communication parameter 1	Setting parameter existence	
		0202H (514)			Read setting	Target station No.
		0203H (515)			Write setting	Request interval timer value Set time = set value × 10ms
		0204H (516)				Response monitoring timer value/ Broadcast delay value Set time = set value × 10ms
		0205H (517)				Type specification of the target MODBUS® device
		0206H (518)			Read setting	Head buffer memory address
		0207H (519)				Target MODBUS® device head number
		0208H (520)				Access points
		0209H (521)			Write setting	Head buffer memory address
		020AH (522)				Target MODBUS® device head number
		020BH (523)				Access points
		020CH to 037FH (524 to 895)			CH1 Automatic communication parameter 2 to 32	(Same as CH1 Automatic communication parameter 1)
		0380H to 04FFH (896 to 1279)			CH2 Automatic communication parameter 1 to 32	(Same as CH1 Automatic communication parameter 1)
		0500H to 08FFH (1280 to 2303)				System area (use prohibited)

Description						
Address Hexadecimal (decimal)	AJ71UC24-S2/A1SJ71UC24-R2-S2/ A1SJ71UC24-R4-S2	Address Hexadecimal (decimal)	QJ71MB91			
	Name		Application	Name		
0044H to 0DEFH (68 to 3551)	User area	0900H (2304)	MODBUS® device assignment parameter	Coil assignment 1	Device code	
		0901H (2305)			Head device number	
		0902H (2306)			Head coil number	
		0903H (2307)			Assignment points	
		0904H to 093FH (2308 to 2367)		Coil assignment 2 to 16	(Same as in Coil assignment 1)	
		0940H (2368)		Input assignment 1	Device code	
		0941H (2369)			Head device number	
		0942H (2370)			Head coil number	
		0943H (2371)			Assignment points	
		0944H to 097FH (2372 to 2431)		Input assignment 2 to 16	(Same as input assignment 1)	
		0980H (2432)		Input register assignment 1	Device code	
		0981H (2433)			Head device number	
		0982H (2434)			Head input register number	
		0983H (2435)			Assignment points	
		0984H to 09BFH (2436 to 2495)		Input register assignment 2 to 16	(Same as in input register assignment 1)	
		09C0H (2496)		Holding register assignment 1	Device code	
		09C1H (2497)	Head device number			
		09C2H (2498)	Head input register number			
		09C3H (2499)	Assignment points			
		09C4H to 09FFH (2500 to 2559)	Holding register assignment 2 to 16	(Same as in holding register assignment 1)		
		0A00H to 0BFFH (2560 to 3071)	System area (use prohibited)			
		0C00H (3072)	Setting status	Intelligent function module switch setting status	Switch 1: CH1 operation mode setting status	
		0C01H (3073)			Switch 2: CH1 transmission setting status	
		0C02H (3074)			Switch 3: CH2 operation mode setting status	
		0C03H (3075)			Switch 4: CH2 transmission setting status	
		0C04H (3076)			Switch 5: CH1/CH2 Station No. setting status	

Description								
Address Hexadecimal (decimal)	AJ71UC24-S2/A1SJ71UC24-R2-S2/ A1SJ71UC24-R4-S2	Address Hexadecimal (decimal)	QJ71MB91					
	Name		Application	Name				
0044H to 0DEFH (68 to 3551)	User area	0C05H (3077)	Operating status	Module status	LED ON status			
		0C06H (3078)		Intelligent function module switch operating status	Switch 1: CH1 operation mode status			
		0C07H (3079)			Switch 2: CH1 transmission status			
		0C08H (3080)			Switch 3: CH2 operation mode status			
		0C09H (3081)			Switch 4: CH2 transmission status			
		0C0AH (3082)			Switch 5: CH1/CH2 Station No. status			
		0C0BH to 0C12H (3083 to 3090)		System area (use prohibited)				
		0C13H (3091)		Parameter error information	MODBUS® device assignment parameter error code storage area			
		0C14H (3092)			MODBUS® device assignment parameter setting result storage area	Error, device type		
		0C15H (3093)			Error, assigned group No.			
		0C16H (3094)			CH1 Automatic communication parameter error code storage area			
		0C17H (3095)			CH1 Automatic communication parameter setting result storage area			
		0C18H (3096)			CH2 Automatic communication parameter error code storage area			
		0C19H (3097)			CH2 Automatic communication parameter setting result storage area			
		0C1AH to 0C1FH (3098 to 3103)			System area (use prohibited)			
		0C20H to 0C21H (3104 to 3105)			Communication condition monitor area	CH1 Automatic communication operation status storage area (Parameters 1 to 32)		
		0C22H to 0C23H (3106 to 3107)				CH2 Automatic communication operation status storage area (Parameters 1 to 32)		
		0C24H to 0C27H (3108 to 3111)		System area (use prohibited)				
		0C28H to 0C47H (3112 to 3143)		CH1 Automatic communication error code storage area (Parameters 1 to 32)				
		0C48H to 0C67H (3144 to 3175)		CH2 Automatic communication error code storage area (Parameters 1 to 32)				
		0C68H to 0CA7H (3176 to 3239)		System area (use prohibited)				
		0CA8H to 0A9H (3240 to 3241)		CH1 Automatic communication setting status storage area (Parameters 1 to 32)				
		0CAAH to 0CABH (3242 to 3243)		CH2 Automatic communication setting status storage area (Parameters 1 to 32)				
		0CACH to 0CAFH (3244 to 3247)		System area (use prohibited)				
		0CB0H to 0CB1H (3248 to 3249)		Communication condition monitor area		CH1 Automatic communication ready status storage area (Parameters 1 to 32)		
		0CB2H to 0CB3H (3250 to 3251)			CH2 Automatic communication ready status storage area (Parameters 1 to 32)			
		0CB4H to 0CFDH (3252 to 3325)			System area (use prohibited)			

Description						
Address Hexadecimal (decimal)	AJ71UC24-S2/A1SJ71UC24-R2-S2/ A1SJ71UC24-R4-S2	Address Hexadecimal (decimal)	QJ71MB91			
	Name		Application	Name		
0044H to 0DEFH (68 to 3551)	User area	0CFEH (3326)	Operating status	Error log	Number of errors occurred	
		0CFFH (3327)			Error log write pointer	
		0D00H (3328)			Error log 1	Detailed error code
		0D01H (3329)				Exception code
		0D02H (3330)				Function code
		0D03H (3331)				CH
		0D04H (3332)				Station No.
		0D05H to 0D06H (3333 to 3334)				System area (use prohibited)
		0D07H (3335)				Function
		0D08H to 0DEFH (3336 to 3551)				
0DF0H to 0DFFH (3552 to 3583)	Use prohibited	0DF0H to 0DFFH (3552 to 3583)	Error log 2 to 32	(Same as Error log 1)		
0E00H to 0EFFH (3584 to 3839)	(Vacant area)	0E00H to 0EFFH (3584 to 3839)	System area (use prohibited)			

Description					
QJ71MB91					
Address Hexadecimal (decimal)	Application	Name			
0F00H (3840)	Communication status	CH1 Communication status	Bus message count		
0F01H (3841)			Diagnostic data for Master/ Slave	Bus communication error count	
0F02H (3842)				Character overrun error count	
0F03H (3843)				Message discard count	
0F04H (3844)				Data discard count	
0F05H (3845)				Failed transmission count	
0F06H (3846)				Diagnostic data for Slave	Slave message count
0F07H (3847)					Slave no-response count
0F08H (3848)					Slave NAK count
0F09H (3849)					Slave busy count
0F0AH (3850)					Exception error count
0F0BH (3851)					Communications event count
0F0CH (3852)					2nd byte of end code
0F0DH (3853)				Communications mode	
0F0EH (3854)		Diagnostic data for Master		Received exception error count	
0F0FH (3855)			No-response count		
0F10H (3856)			Broadcast count		
0F11H (3857)			Received NAK count		
0F12H (3858)		Received busy count			
0F13H to 0F1EH (3859 to 3870)			System area (use prohibited)		
0F1FH (3871)			Communication event log (for Slave)	Communications event log count	
0F20H to 0F3FH (3872 to 3903)				Communications event log 1 to 64	
0F40H to 0F7FH (3904 to 3967)			CH2 Communication status	(Same as CH1 communication status)	
0F80H to 0FFDH (3968 to 4093)			System area (use prohibited)		
0FFEH (4094)		Unit test result	Hardware test result		
0FFFH (4095)			Self-loopback test result		
1000H to 1FFFH (4096 to 8191)		Automatic communication function buffer	CH1 Automatic communication function buffer input area		
2000H to 2FFFH (8192 to 12287)			CH2 Automatic communication function buffer input area		
3000H to 3FFFH (12288 to 16383)	CH1 Automatic communication function buffer output area				
4000H to 4FFFH (16384 to 20479)	CH2 Automatic communication function buffer output area				
5000H to 5FFFH (20480 to 204575)	User free area				

7.6 Program Diversion

If the sequence program of the existing A/AnS series MODBUS® interface module is diverted to the Q series MODBUS® interface module, the sequence program needs to be reviewed and corrected. Review and correct the program as follows.

(1) Communication setting (mode setting, transmission speed etc.)

The hardware switch setting is changed to the GX Developer Intelligent Function Module Switch Setting or GX Works2 Intelligent Function Module Setting. Make settings by referring to the "MODBUS® Interface Module User's Manual".

(2) I/O signals

The A/AnS series MODBUS® interface module and the Q series MODBUS® interface module are not compatible with regard to the assignments of I/O signals. Review and correct the sequence program.

(3) Buffer memory

The A/AnS series MODBUS® interface module and the Q series MODBUS® interface module are not compatible with regard to the assignments of buffer memory due to an increase of MODBUS® device size and function addition.

Review and correct the sequence program.

Note that "RS-232C side" of the A/AnS series module in Section 7.5.2 corresponds to "CH1" of the Q series module, and "RS-422/485 side" of the A/AnS series module corresponds to "CH2" of the Q series module.

☒ Point

Q series module QJ71MB91 allows for taking advantage of utility package GX Configurator-MB. GX Configurator-MB is a tool for supporting the parameter setting, auto refresh, and monitor/test of QJ71MB91.

Using GX Configurator-MB eliminates the need for the sequence programs for parameter setting and auto refresh.

For more information including the setting method, refer to the "MODBUS® Interface Module User's Manual".

(4) Functions of the Utility Package GX Configurator-MB

Item	Description
Initial setting	Set the following items that require initial setting. <ul style="list-style-type: none"> • Automatic communication parameter • MODBUS® device assignment parameter The initially set data are registered as programmable controller CPU parameters, and are automatically written to the QJ71MB91 when the programmable controller CPU enters RUN status.
Auto refresh setting	The QJ71MB91's buffer memory is configured for automatic refresh. <ul style="list-style-type: none"> • Automatic communication function buffer input area • Automatic communication function buffer output area • Automatic communication operation status storage area • User free area (input/output) The QJ71MB91 buffer memory area data set for auto refresh are automatically read from or written to the specified devices when the END instruction of the programmable controller CPU is executed.
Monitor/test	The buffer memory and I/O signals of the QJ71MB91 are monitored or tested. <ul style="list-style-type: none"> • Operation mode setting status • Transmission setting status • Station No. setting status • Various module statuses • X/Y Monitor/test • MODBUS® device assignment parameter status • Automatic communication status • Error log • Communication status

8 DeviceNet MODULE REPLACEMENT

8.1 List of DeviceNet Modules to be Replaced

A/AnS series model	Alternative models	Remarks
AJ71DN91 A1SJ71DN91	QJ71DN91	Master modules are replaced by a master/slave module.

8.2 Performance Specifications Comparison

○: Compatible △: Partly changed ×: Incompatible

Item				A/AnS series		Q series	Compat- ibility	Precautions for replacement																						
				AJ71DN91	A1SJ71DN91	QJ71DN91																								
Communication specifications	Master function	Node type		Group 2 only client			○																							
		Station numbers that may be set		0 to 63			○																							
		Number of connections that can be generated		63 for I/O communication and 63 for message communication			○																							
		Communication data size	I/O communication	Send	2048 points Up to 256 bytes per station	Max. 4096 points (512 bytes), max. 256 bytes per node		○																						
				Receive	2048 points Up to 256 bytes per station	Max. 4096 points (512 bytes), Up to 256 bytes per station		○																						
		Message communication		Send	Max. 240 bytes			○																						
	Receive			Max. 240 bytes			○																							
	Slave function	Node type		(Slave function not supported)	DeviceNet slaves (Group 2 server)		-	New function of QJ71DN91																						
		Station numbers that may be set			0 to 63																									
		Number of connections that can be generated (I/O connections)			1 (polling)																									
		Communication data size	I/O communication		Send	Max. 1024 points (128 bytes)																								
	Receive			Max. 1024 points (128 bytes)																										
	Communication speed				Selectable from 125kbps, 250kbps and 500kbps.			○																						
	Maximum cable length*1				<table border="1"> <thead> <tr> <th rowspan="2">Communication speed</th> <th colspan="2">Maximum trunk line distance</th> <th rowspan="2">Combination of thick and thin cables</th> <th colspan="2">Drop line length</th> </tr> <tr> <th>Thick cables</th> <th>Thin cables</th> <th>Maximum</th> <th>Total</th> </tr> </thead> <tbody> <tr> <td>125kbaud</td> <td>500m</td> <td rowspan="2">100m</td> <td rowspan="3">See*2.</td> <td rowspan="3">6m</td> <td>156m</td> </tr> <tr> <td>250kbaud</td> <td>250m</td> <td>78m</td> </tr> <tr> <td>500kbaud</td> <td>100m</td> <td>39m</td> </tr> </tbody> </table>		Communication speed	Maximum trunk line distance		Combination of thick and thin cables	Drop line length		Thick cables	Thin cables	Maximum	Total	125kbaud	500m	100m	See*2.	6m	156m	250kbaud	250m	78m	500kbaud	100m	39m	○	
	Communication speed	Maximum trunk line distance		Combination of thick and thin cables	Drop line length																									
Thick cables		Thin cables	Maximum		Total																									
125kbaud	500m	100m	See*2.	6m	156m																									
250kbaud	250m				78m																									
500kbaud	100m	39m																												
Current consumption required on the network				26.5mA		30.0mA	○																							
Number of writes to E ² PROM				Max. 100,000 times		-	○	The memory type is different.																						
Number of writes to flash ROM				-		Max. 100,000 times																								
Number of occupied I/O points				Special 32 points		32 points (I/O allocation: Intelligent 32 points)	○																							
5VDC internal current consumption				0.24A		0.17A	○																							
Weight				0.43kg		0.23kg	0.11kg	○																						

*1 The maximum cable length complies with the DeviceNet Specifications (Release 2.0) Volumes 1 and 2.

*2 The maximum transmission distance of the trunk line when thick and thin cables are both used is as follows.

Communication speed	Maximum transmission distance of trunk line when thick and thin cables coexist
125kbaud	Thick cable length + 5 × thin cable length ≤ 500m
250kbaud	Thick cable length + 2.5 × thin cable length ≤ 250m
500kbaud	Thick cable length + thin cable length ≤ 100m

8.3 Function Comparison

(1) Comparison of master and slave functions

○: Function available △: Restricted -: Function unavailable

Item		Description	AJ71DN91 A1SJ71DN91	QJ71DN91	Precautions for replacement
Master function	I/O communication	The master node can exchange I/O data with each slave node (up to 63 nodes). Transfer of 512 input bytes (up to 256 bytes per node) and 512 output bytes (up to 256 bytes per node) is available. The connection type can be selected for each slave node.	○	○	
	Message communication	The master node can read/write the attribute data of the slave node. For further details of message communication, refer to the DeviceNet common service in the DeviceNet Specifications (Release 2.0). Up to 240 bytes of message data can be transferred at a time.	○	○	
Slave function	I/O communication	The slave node can exchange I/O data with the master node. Transfer of 128 input bytes and 128 output bytes is available. The connection type is polling method.	-	○	This function has been added to QJ71DN91. A(1S)J71DN91 does not have the slave function.

(2) Comparison of configuration functions

○: Function available △: Restricted -: Function unavailable

Item		Description	AJ71DN91 A1SJ71DN91	QJ71DN91	Precautions for replacement
Own node setting		This function sets the number of the own node.	○	△	A(1S)J71DN91 uses the sequence program for the setting, and QJ71DN91 uses the hardware switch for the setting.
Communication speed setting		This function sets the communication speed (baud rate). QJ71DN91 sets the master and slave functions as well.	○	△	A(1S)J71DN91 uses the sequence program for the setting, and QJ71DN91 uses the hardware switch for the setting.
Saving parameters to flash ROM/E ² ROM		The following parameters in the buffer memory can be stored in the flash ROM/E ² ROM. E ² ROM inside A(1S)J71DN91 • Parameters for Master Function (Address: 01D4H to 03CFH) Flash ROM inside QJ71DN91 • Parameters for Master Function (Address: 01D4H to 03CFH) • Parameters for Slave Function (Address: 060EH, 060FH) • Auto Communication Start Setting (Address: 0631H) The parameters saved to the flash ROM/E ² ROM are automatically loaded to the buffer memory when power is turned on from off or when the CPU module is reset.	○	○	
Auto configuration		This function detects slave nodes on the network, allowing automatic configuration of master function parameters. A(1S)J71DN91 • Auto configuration is performed with configuration software. QJ71DN91 • Auto configuration is performed when "Auto configuration request Y15" is turned on. Two options are available: "All configuration" used to detect all slave nodes on the network and "Add configuration" used to detect the slave node(s) added to the network. Programming steps for setting the master function parameters can be reduced.	△	○	"Auto configuration request Y15" is a function added to QJ71DN91. A(1S)J71DN91 requires configuration software sold separately if the master function parameters are set using something other than the sequence program.

8.4 Switch Settings Comparison

○: Compatible △: Partly changed ×: Incompatible

Switch name	Setting	A/AnS series		Q series	Compat- ibility	Precautions for replacement
		AJ71DN91/A1SJ71DN91		QJ71DN91		
Node No. setting switch	Own node number (own node MAC ID)	Setting into buffer memory		Using the hardware switch on the front panel of the module	×	Set the existing own node number using the hardware switch.
Mode setting switch	Baud rate	Setting into buffer memory		-	×	Conventionally only the master function is available. Set 0 to 2 in accordance with the existing baud rate.
	Selection of master and slave functions, and baud rate	-		Using the hardware switch on the front panel of the module*1		
	Hardware test					
	Communication test					

*1 Hardware switch settings

Setting	Function	Description
0	Master function	Operates as a master node, at communication speed of 125k baud(factory default).
1		Operates as a master node, at communication speed of 250k baud.
2		Operates as a master node, at communication speed of 500k baud.
3	Slave function	Operates as a slave node, at communication speed of 125k baud.
4		Operates as a slave node, at communication speed of 250k baud.
5		Operates as a slave node, at communication speed of 500k baud.
6	Master and slave functions	Operates as a master and slave node, at communication speed of 125k baud.
7		Operates as a master and slave node, at communication speed of 250k baud.
8		Operates as a master and slave node, at communication speed of 500k baud.
9	Hardware test	Performs the ROM/RAM check and self-loopback test.
A	Communication test	Performs the transmit/receive test, at communication speed of 125k baud.
B		Performs the transmit/receive test, at communication speed of 250k baud.
C		Performs the transmit/receive test, at communication speed of 500k baud.
D to F	Use prohibited	-

8.5 Program Comparison

8.5.1 I/O signals

(1) Input signal

The input signals of AJ71DN91/A1SJ71DN91 and QJ71DN91 are the same except added functions. When added functions are not used, existing programs can be used without modification.

○: Compatible △: Partly changed ×: Incompatible

Input signal	Signal name		Compat- ibility	Precautions for replacement
	AJ71DN91/A1SJ71DN91	QJ71DN91		
X00	Watchdog Timer Error		○	
X01	I/O Communicating		○	
X02	Message Communication Completion		○	
X03	Error Set Signal for Master Function		○	
X04	Slave Down Signal		○	
X05	Message Communication Error Signal		○	
X06	Parameter being set	Saving Parameters to Flash ROM	△	A(1S)J71DN91 saves to E ² ROM.
X07	Parameter setting complete	Parameters Saved to Flash ROM	△	
X08	Unusable	Error Set Signal for Slave Function	-	This function has been added to QJ71DN91. (This function is for the slave function and is not used for the master function.)
X09	Use prohibited		-	
X0A	Unusable	H/W Test in Progress	△	This function has been added to QJ71DN91.
X0B		H/W Test Completion	△	
X0C		H/W Test Error Detection	△	
X0D	Use prohibited		-	
X0E	Use prohibited		-	
X0F	Module Ready		○	
X10	Use prohibited		-	
X11				
X12				
X13				
X14	Unusable	Auto-Configuring	△	This function has been added to QJ71DN91.
X15		Auto Configuration Completion	△	
X16	Use prohibited		-	
X17				
X18				
X19				
X1A				
X1B				
X1C				
X1D				
X1E				
X1F				

(2) Output signal

The input signals of AJ71DN91/A1SJ71DN91 and QJ71DN91 are the same except added functions.
When added functions are not used, existing programs can be used without modification.

○: Compatible △: Partly changed ×: Incompatible

Output signal	Signal name		Compat- ibility	Precautions for replacement
	AJ71DN91/A1SJ71DN91	QJ71DN91		
Y00				
Y01				
Y02				
Y03				
Y04				
Y05				
Y06				
Y07				
Y08	Use prohibited		-	
Y09				
Y0A				
Y0B				
Y0C				
Y0D				
Y0E				
Y0F				
Y10				
Y11	I/O Communication Request		○	
Y12	Message Communication Request		○	
Y13	Error Reset Request for Master Function		○	
Y14	Use prohibited		-	
Y15	Unusable	Auto Configuration Request	△	This function has been added to QJ71DN91.
Y16	Use prohibited		-	
Y17	Parameter set request	Request for Saving Parameters to Flash ROM	○	A(1S)J71DN91 saves to E ² ROM.
Y18	Unusable	Error Reset Request for Slave Function	-	This function has been added to QJ71DN91. (This function is for the slave function and is not used for the master function.)
Y19				
Y1A				
Y1B				
Y1C	Use prohibited		-	
Y1D				
Y1E				
Y1F				

8.5.2 Buffer memory

○: Compatible △: Partly changed ×: Incompatible

Address (Hexadecimal)	Description		Compat- ibility	Precautions for replacement
	AJ71DN91/A1SJ71DN91	QJ71DN91		
0000H to 007FH	Input data (Stores input data from each slave station.)	Use prohibited	×	The storage locations of I/O data are different. New address Input (receive) data: 0700H to 07FFH Output (Send) data: 0900H to 09FFH
0080H to 00FFH	Output data (Stores output data for each slave station.)			
0100H to 010FH	Use prohibited		-	
0110H to 011FH	Message Communication Command (A command for message communication is set.)		○	-
0120H to 012FH	Message Communication Result (Stores result data of message communication.)		○	-
0130H to 01A7H	Message Communication Data (Stores transmit and receive data of message communication.)		○	-
01A8H to 01A9H	Model display (Setting is "DN91" in ASCII code)	Use prohibited	×	The storage locations of model display are different. New address: 0620H to 0624H
01AAH to 01AFH	Use prohibited		-	
01B0H	Master Function Communication Status (Stores the communication status of the master function.)		○	
01B1H	Error Information for Master Function (Stores a communication error code of the error occurred.)		○	
01B2H	Bus Error Counter (Stores an illegal frame count of the CAN chip (communication chip for DeviceNet) when it exceeds 96.)		○	
01B3H	Bus Off Counter (Stores the number of times the QJ71DN91 was placed in the bus off status.)		○	
01B4H to 01B7H	Node Configuration Status (Stores parameter setting status of each slave node.)		○	
01B8H to 01BBH	Use prohibited		-	
01BCH to 01BFH	Node Communication Status (Stores I/O communication status of each slave node.)		○	-
01C0H to 01C3H	Not used	Node Communication Error Status (Stores I/O communication error status of each slave node.)	△	This function has been added to QJ71DN91.
01C4H to 01C7H	Node Fault Status (Stores communication fault status of each slave node.)		○	-
01C8H to 01CBH	Use prohibited		-	
01CCH to 01CFH	Failed Node Detection Setting (Whether or not to detect any failed node is set.)		○	
01D0H to 01D3H	Use prohibited		-	
01D4H to 03CFH	Parameters for Master Function (Parameters for master function are set.)			
01D4H	Own station number (own station MAC ID)	Use prohibited	×	Set data using the hardware switch on the front panel of the module
01D5H	Baud rate		×	
01D6H	Unusable		-	
01D7H		Constant scan (Specify to make the link scan time constant.)	△	This function has been added to QJ71DN91.
01D8H to 01DFH	Setting of first slave node (Set information including the connection type and the number of I/O points used for I/O exchange with the first slave node.)		○	
01E0H to 03CFH	Setting of 2nd to 63rd slave nodes		○	

Address (Hexadecimal)	Description		Compat- ibility	Precautions for replacement
	AJ71DN91/A1SJ71DN91	QJ71DN91		
03D0H to 03EFH	(Reserved area)	Use prohibited	-	
03F0H		Auto Configuration Operation Setting (Operation of auto configuration is set.)	△	This function has been added to QJ71DN91.
03F1H to 04FFH		Use prohibited	-	
0500H to 05FBH		I/O Address Area for Master Function (Stores the start addresses and sizes (in word units) of Master Function Receive Data (address: 0700H to 07FFH) and Master Function Transmit Data (address: 0900H to 09FFH) for slave nodes.)	△	This function has been added to QJ71DN91.
05FCH		Present Link Scan Time (Stores the current link scan time. (Unit: ms))	△	This function has been added to QJ71DN91.
05FDH		Minimum Link Scan Time (Stores the minimum link scan time after power-on. (Unit: ms))	△	This function has been added to QJ71DN91.
05FEH		Maximum Link Scan Time (Stores the maximum link scan time after power-on. (Unit: ms))	△	This function has been added to QJ71DN91.
05FFH		Use prohibited	-	
0600H		Slave Function Communication Status (Stores the communication status of the slave function.)	△	This function has been added to QJ71DN91.
0601H		Error Information for Slave Function (Stores a communication error code of the error occurred in the slave function.)	△	(This function is for the slave function and is not used for the master function.)
0602H to 060DH		Use prohibited	-	
060EH		Slave Function Receive-Bytes Setting Area (The I/O receive data size (bytes) for the slave function is set.)	△	This function has been added to QJ71DN91. (This function is for the slave function and is not used for the master function.)
060FH		Slave Function Transmit-Bytes Setting Area (The I/O transmit data size (bytes) for the slave function is set.)	△	
0610H to 061FH		Use prohibited	-	
0620H to 0624H		Model Name (Stores "QJ71DN91" in ASCII code.)	×	The storage locations of model display are different. Existing address: 0620H to 0624H
0625H		Node No. (Stores the number of the node currently in operation.)	△	This function has been added to QJ71DN91.
0626H		Mode Switch No. (Stores the mode switch number currently in operation.)	△	This function has been added to QJ71DN91.
0627H to 062DH		Use prohibited	-	
062EH		Hardware Test Item Area (Stores the test item number of the hardware test or communication test that is currently being executed.)	△	This function has been added to QJ71DN91.
062FH		Hardware Test Result Area (Stores the result of the hardware test or communication test.)	△	This function has been added to QJ71DN91.
0630H		Parameter Area Select Bit (Select the area of the parameters to be saved to a flash ROM.)	△	This function has been added to QJ71DN91.
0631H		Auto Communication Start Setting (Set whether or not to auto-start I/O communication with parameters saved on the flash ROM at the time of power on from off or CPU reset.)	△	This function has been added to QJ71DN91.
0632H		Operation Setting Area for Bus Off Error (Set whether or not to reset the QJ71DN91's CAN chip (communication chip) to restart communications in the event of a bus off error.)	△	This function has been added to QJ71DN91.
0633H to 06FFH		Use prohibited	-	
0700H to 07FFH		Master Function Receive Data (Stores the data received from each slave node.)	×	The storage locations of input data are different. Existing address: Input (receive) data: 0000H to 007FH
0800H to 08FFH		Use prohibited	-	
0900H to 09FFH		Master Function Transmit Data (Data to be sent to each slave node is set.)	×	The storage locations of I/O data are different. Existing address: Output (send) data: 0080H to 00FFH
0A00H to 0AFFH		Use prohibited	-	
0B00H to 0B3FH		Slave Function Receive Data (Stores the data received from the master node.)	△	This function has been added to QJ71DN91. (This function is for the slave function and is not used for the master function.)

Address (Hexadecimal)	Description		Compat- ibility	Precautions for replacement
	AJ71DN91/A1SJ71DN91	QJ71DN91		
0B40H to 0BFFH		Use prohibited	-	
0C00H to 0C3FH	(Reserved area)	Slave Function Transmit Data (Data to be sent to the master node is set.)	△	This function has been added to QJ71DN91. (This function is for the slave function and is not used for the master function.)
0C40H to 7FFFH		Use prohibited	-	

8.6 Program Diversion

When the sequence program of the existing A/AnS series DeviceNet master module is diverted, the following points need to be reviewed or modified: buffer memory addresses are different, node number setting methods are different, and so on.

When a sequence program is diverted, review and correct the program as follows.

(1) Own node number setting (MAC ID)

The setting using the TO instruction changes to the setting using the hardware switch on the front panel of the module.

Make settings by referring to the "DeviceNet Master/Slave Module User's Manual" for details.

(2) Baud rate setting

The setting using the TO instruction changes to the setting using the hardware switch on the front panel of the module.

The A/AnS series module has only the master function and simply sets the baud rate, but the Q series module has the master and slave functions and needs to select the master and slave function as well. Make settings by referring to the "DeviceNet Master/Slave Module User's Manual" for details.

(3) Input/output signal

The I/O signal addresses for the master function are the same.

(4) Buffer memory

(a) Input/output data storage area

Buffer memory addresses change due to an increase of input/output data sizes, function addition, and so on.

The access destination addresses of the FROM-TO instruction need to be reviewed and modified. If the parameters for slave node information setting are not changed, the devices assigned to I/O data do not need to be changed.

(b) Parameter setting area for slave node information setting

The buffer memory addresses of the parameter setting area for slave node information setting are equivalent.

If a sequence program is used to set parameters for slave node information setting, the program can be diverted without modification.

Review and modify the program by referring to the "DeviceNet Master/Slave Module User's Manual" for details.

(5) Parameter setting for slave node information setting

The A/AnS series module uses a sequence program or configuration software (sold separately) to set these parameters.

The Q series module sets the parameters by auto configuration and can eliminate the need for creating a sequence program.

Note that if auto configuration is used to set these parameters, they may differ from the contents of the setting by the existing sequence program.

Make settings by referring to the "DeviceNet Master/Slave Module User's Manual" for details.

(6) I/O data consistency dedicated instructions

QJ71DN91 has dedicated instructions to read/write I/O data while preventing data inconsistency.

To prevent I/O data inconsistency, correct/change the sequence program to the dedicated instructions.

(a) Dedicated instruction list

Dedicated instructions	Function overview
DNTMRD	This instruction reads data from the master function receive data area of the specified module while preventing data inconsistency.
DNTMWR	This instruction writes data to the master function send data area of the specified module while preventing data inconsistency.
DNTSRD	This instruction reads data from the slave function receive data area of the specified module while preventing data inconsistency.
DNTSWR	This instruction writes data to the slave function send data area of the specified module while preventing data inconsistency.

For details, refer to the "DeviceNet Master/Slave Module User's Manual".

9 PROFIBUS-DP MODULE REPLACEMENT

9.1 List of PROFIBUS-DP Modules to be Replaced

Type	A/AnS series model	Alternative models	Remarks
Master module	AJ71PB92D	QJ71PB92V	Set the QJ71PB92D compatibility function to QJ71PB92V before using it.*1
	A1SJ71PB92D		
Slave module	A1SJ71PB93D	QJ71PB93D	

*1 The QJ71PB92D compatibility function of QJ71PB92V is functionally compatible with AJ71PB92D/A1SJ71PB92D although the I/O signals and buffer memory addresses are partly different.

9.2 PROFIBUS-DP Master Module Replacement

9.2.1 Performance specifications comparison

○: Compatible △: Partly changed ×: Incompatible

Item	A/AnS series		Q series module	Compat- ibility	Precautions for replacement
	AJ71PB92D	A1SJ71PB92D	QJ71PB92V (QJ71PB92D compatibility function)		
PROFIBUS-DP station type	Class 1 master station (EN50170 compliant)			○	
Electrical standard/ characteristics	EIA-RS485 compliant			○	
Medium	Shielded twisted pair cable			○	
Terminating resistor	Built in the module (Selection of terminating resistor presence/ absence)		Mounted by user (Terminating node only)	×	When diverting the existing cable, use a connector with built-in terminating resistor.*3
Network topology	Bus topology (Tree topology when repeaters are used)			○	
Data link method	Between master station and master station: Token passing method Between master station and slave station: Polling method			○	
Encoding method	NRZ			○	
Transmission speed	9.6kbps to 12Mbps*1			○	
Transmission distance	Differs depending on the transmission speed*1			○	
Max. No. of repeaters	3 repeaters			○	
Number of connectable modules (Per segment)	32 per segment (including repeater(s))			○	
Number of connectable modules (Per network)	126 per network (including master stations and slave stations)			○	
Max. number of slave nodes (per master node)	60 per station (slave)			○	
Input data size	Input data	Normal service mode: 32 bytes per slave station Extended service mode: Max. 1920 bytes (Max. 244 bytes per slave station)		○	
	Output data	Normal service mode: 32 bytes per slave station Extended service mode: Max. 1920 bytes (Max. 244 bytes per slave station)		○	
Number of writes to E ² PROM	Max. 10,000 times		-	△	Functions are equivalent although the memory type is different.
Number of writes to flash ROM	-		Max. 100,000 times		
Number of occupied I/O points	32 (I/O assignment: 32 special points)		32 points (I/O assignment: 32 intelligent points)	○	
5VDC internal current consumption	0.54A	0.56A	0.57A	○	
Weight	0.37kg	0.27kg	0.15kg	○	

*1 Transmission speeds and distances are summarized as follows.

Transmission speed	Transmission distance	Max. transmission distance when repeaters are used*2
9.6kbps	1200m/segment	4800m/network
19.2kbps		
93.75kbps		
187.5kbps	1000m/segment	4000m/network
500kbps	400m/segment	1600m/network
1.5Mbps	200m/segment	800m/network
3Mbps	100m/segment	400m/network
6Mbps		
12Mbps		

*2 Each maximum transmission distance in the above table is an example when three repeaters are used. The following shows the calculation formula when the transmission distance is extended using repeaters.

$$\text{Max. transmission distance [m/network]} = (\text{number of repeaters} + 1) \times \text{transmission distance [m/segment]}$$

*3 When QJ71PB92V (QJ71PB92D compatibility function) is a terminal node, use a connector with built-in terminating resistor that satisfies the following wiring specifications.

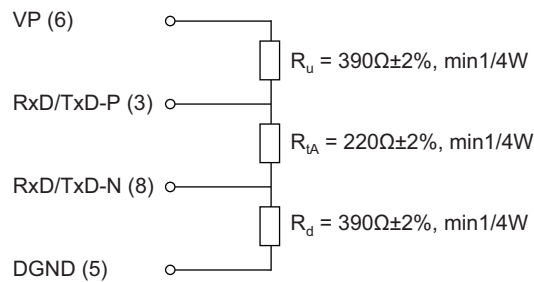

9.2.2 Compatible software package (configuration software)

○: Compatible △: Partly changed ×: Incompatible

Type	AJ71PB92D A1SJ71PB92D	QJ71PB92V (QJ71PB92D compatibility function)	Compat- ibility	Precautions for replacement
Compatible software package ^{*1}	GX Configurator-DP Version 4 or later	GX Configurator-DP Version □ or later Depends on the QCPU type. ^{*2}	△	There are some incompatible versions.
	SW0D5F-ProfiMap MELSEC ProfiMap Version 2 MELSEC ProfiMap Version 3	-	×	Use GX Configurator-DP.

*1 The connection method of the PC in which the software package is installed differs. For details of the connection method, refer to the User's Manual of each module.

*2 Compatible software package versions for individual CPU types

Installed QCPU	Software version		
	Programming tool		Configuration software
	GX Developer	GX Works2	GX Configurator-DP
Q00J/Q00/Q01CPU	Version 7 or later	Version 1.11M or later	Version 5 or 6 Version 7.01B or later
Q02/Q02H/Q06H/Q12H/ Q25HCPU	Version 4 or later		Version 4 or 6 Version 7.01B or later
Q02PH/Q06PHCPU	Version 8.68W or later	Version 1.86Q or later	Version 7.04E or later
Q12PH/Q25PHCPU	Version 7.10L or later		Version 4 or 6 Version 7.01B or later
Q12PRH/Q25PRHCPU	Version 8.17T or later		Version 7.03D or later
Q00JCPU	Version 8.76E or later	Version 1.11M or later	Version 7.04E or later
Q00U/Q01UCPU			Version 7.04D or later
Q02UCPU	Version 8.48A or later		Version 7.02C or later
Q03UD/Q04UDH/ Q06UDHCPU			Version 7.04E or later
Q10UDH/Q20UDHCPU			Version 7.03D or later
Q13UDH/Q26UDHCPU	Version 8.62Q or later		
Q03UDV/Q04UDV/ Q06UDV/Q13UDV/ Q26UDVCP	Use prohibited	Version 1.95Z or later	Version 7.09K or later
Q03UDE/Q04UDEH/ Q06UDEH/Q13UDEH/ Q26UDEHCPU	Version 8.68W or later	Version 1.11M or later	Version 7.03D or later
Q10UDEH/Q20UDEHCPU	Version 8.76E or later		Version 7.04E or later
Q50UDEH/Q100UDEHCPU	Use prohibited	Version 1.25B or later	Version 7.07H or later

9.2.3 Function comparison

○: Function available - : Function unavailable

Function	Description	A/AnS	Q	Precautions for replacement
PROFIBUS-DPV0	-			
I/O data exchange	I/O data exchange with up to 60 DP-Slaves is performed.	○	○	
Acquisition of diagnostic and extended diagnostic information	Diagnostic or extended diagnostic information of an error occurred on a DP-Slaves during I/O data exchange can be easily acquired using the buffer memory and I/O signals.	○	○	
Global control function	By sending services (SYNC, UNSYNC, FREEZE, UNFREEZE) to each DP-Slave in a group, synchronous control of DP-Slave I/O data is available.	○	○	
Data swap function	This function swaps the upper and lower bytes in word units when I/O data is sent and received.	-	○	Function added to QJ71PB92V
Data consistency function	When I/O data from DP-Slaves are read from or written to the buffer memory, this function prevents the I/O data from being separated and incorrectly mixed.			For prevention of data inconsistency, change the FROM/TO instructions to auto refresh setting or dedicated instructions.
	• Automatic refresh setting (GX Configurator-DP)	-	○	
	• Dedicated instructions (BBLKRD and BBLKWR instructions)	○	-	
• FROM/TO instructions		○	-	
Output status setting for the case of a CPU stop error	This function sets whether to stop or continue I/O data exchange with DP-Slaves when a CPU stop error occurs on a QCPU or remote I/O station where the QJ71PB92V is mounted.	-	○	Function added to QJ71PB92V
Operation mode switching function	This function selects/sets the operation mode of A(1S)J71PB92D/QJ71PB92V.*1 Use the sequence program (A/AnS/Q) or mode setting switch (A/AnS) for the setting.	○	○	Functions are equivalent although the setting method differs partly.

*1 Operation mode list

○: Function available - : Function unavailable

Operation mode	Description	Operation mode change operation			
		Operation mode Change request		Mode Setting Switch	
		A/AnS	Q	A/AnS	Q
Normal service mode (MODE 0)	I/O data exchange with slave stations is performed in this mode. The I/O area assigned to each slave station has a fixed capacity of 32 bytes.	○	○	○	-
Extended service mode (MODE E)	I/O data exchange with slave stations is performed in this mode. The I/O area for each slave station is assigned based on the variable data length (in byte units) for each station. The data length (in byte units) for each station is set as a slave parameter (Select Modules) in GX Configurator-DP.	○	○	○	-
Parameter setting mode (MODE 1)	The parameters set on GX Configurator-DP are written to QJ71PB92D in this mode.	○	○	○	-
Self-diagnosis mode (MODE 2)	The unit test on the QJ71PB92D is performed in this mode.	-	○	○	-
E ² PROM initialization function	This mode is used to return the AJ71PB92D/A1SJ71PB92D to the factory default status.	-	-	○	-
Flash ROM initialization mode	This mode is used to return the QJ71PB92V to the factory default status.	-	○	-	-

9.2.4 Input/output signal comparison

(1) Input signal

Of the input signals, the "watchdog timer error signal" changes from X0D of AJ71PB92D/A1SJ71PB92D to "X1F" of QJ71PB92V (QJ71PB92D compatibility function). Existing programs need to be corrected when diverted.

○: Compatible △: Partly changed ×: Incompatible

Input signal	Signal name		Compat- ibility	Precautions for replacement
	AJ71PB92D A1SJ71PB92D	QJ71PB92V (QJ71PB92D compatibility function)		
X00	Exchange start end signal		○	
X01	Communication trouble detection signal		○	
X02	Communication trouble area clear end signal		○	
X03	Use prohibited		-	
X04	Global control end signal		○	
X05	Global control error end signal		○	
X06	Use prohibited		-	
...				
X0C	Use prohibited		-	
X0D	Watchdog timer error signal	Use prohibited	×	The device numbers of the same function are different.
X0E	Use prohibited		-	
X0F	Use prohibited		-	
X10	Operation mode signal		○	
X11	Operation mode change completion signal		○	
X12	Use prohibited		-	
...				
X1A	Use prohibited		-	
X1B	Communication READY signal		○	
X1C	Use prohibited		-	
X1D	Module READY signal		○	
X1E	Use prohibited		-	
X1F	Use prohibited	Watchdog timer error signal	×	The device numbers of the same function are different.

(2) Output signal

The output signals of AJ71PB92D/A1SJ71PB92D and QJ71PB92V (QJ71PB92D compatibility function) are the same except the function of "Y0C: dedicated instruction effective signal" that has been added. Existing programs do not need to be corrected when diverted (dedicated instructions are not used).

○: Compatible △: Partly changed ×: Incompatible

Output signal	Signal name		Compat- ibility	Remarks
	AJ71PB92D A1SJ71PB92D	QJ71PB92V (QJ71PB92D compatibility function)		
Y00	Exchange start request signal		○	
Y01	Communication trouble detection signal reset		○	
Y02	Communication trouble area clear request signal		○	
Y03	Use prohibited		-	
Y04	Global control request signal		○	
Y05	Use prohibited		-	
...				
Y0B				
Y0C	Use prohibited	Dedicated instruction valid signal	△	Dedicated instruction compatible signal added to QJ71PB92V
Y0D	Restart request signal		○	
Y0E	Use prohibited		-	
...				
Y10				
Y11	Operation mode change request signal		○	
Y12	Use prohibited		-	
...				
Y1F				

9.2.5 Buffer memory

The buffer memory of AJ71PB92D/A1SJ71PB92D and QJ71PB92V (QJ71PB92D compatibility function) are assigned the same except a function added part. Existing programs can be diverted.

○: Compatible △: Partly changed ×: Incompatible

Address Decimal (hexadecimal)	Description		Compat- ibility	Precautions for replacement
	AJ71PB92D A1SJ71PB92D	QJ71PB92V (QJ71PB92D compatibility function)		
0000 to 0959 (0000H to 3BFH)	Input area (This area is for storing the input data from the slave.)		○	
0960 to 1919 (3C0H to 77FH)	Output area (This area is for storing the output data to the slave.)		○	
1920 to 2039 (780H to 7F7H)	Address information area (This area is for showing the station number of slave station and I/O data length.)		○	
2040 to 2079 (7F8H to 81FH)	Communication trouble area (This area is for showing the trouble information that occurred during communication.)		○	
2080 (820H)	Slave error information cancel area (This area is for setting the data that masks the slave trouble information.)		○	
2081 (821H)	Global control area (This area is the global control function hold/cancel selection area.)		○	
2082 to 2083 (822H to 823H)	System area (Use prohibited)		-	
2084 (824H)	Trouble no information time setting area (This area is used to set the time that does not inform the communication trouble after the exchange start.)		○	
2085 to 2095 (825H to 82FH)	System area (Use prohibited)		-	
2096 to 2110 (830H to 83EH)	Expansion communication trouble area (This area shows the expansion information of the trouble information which is occurred during the communication.)		○	
2111 (83FH)	System area (Use prohibited)		-	
2112 to 2116 (840H to 844H)	Slave status area (This area is for showing the status information of each slave.)		○	
2117 to 2127 (845H to 84FH)	System area (Use prohibited)		-	
2128 to 2247 (850H to 8C7H)	Input/Output start address area (Extended service mode only) (This area is for showing the addresses to start the input area and output area of each slave.)		○	
2248 to 2253 (8C8H to 8CDH)	System area (Use prohibited)		-	
2254 (8CEH)	Current operation mode (This area indicates the operation mode of the QJ71PB92D when it has started up.)		○	
2255 (8CFH)	Operation mode change request area (In this area, set the operation mode of the QJ71PB92D which is to be changed.)		○	
2256 (8D0H)	Operation mode change result area (This area indicates the execution result of the operation mode change request.)		○	
2257 (8D1H)	System area (Use prohibited)	Local station number display area (Area in which the station number of the local station is stored.)	△	This area is added to QJ71PB92V (QJ71PB92D compatibility function). With the AJ71PB92D/A1SJ71PB92D, check with the LED indications on the front panel of the module.
2258 (8D2H)	Self-diagnosis status code area (Area in which the code indicating the status of the self-diagnosis during the execution of the diagnosis is stored.)		○	
2259 to 3775 (8D3H to EBFH)	System area (Use prohibited)		-	

9.2.6 Program diversion

This section describes the methods of diverting parameters and programs when replacing the existing AJ71PB92D/A1SJ71PB92D with QJ71PB92V (QJ71PB92D compatibility function).

(1) Parameter setting

(a) When configuration software ProfiMap is used

Configuration software ProfiMap cannot be used with the QJ71PB92V (QJ71PB92D compatibility function).

Configuration software GX Configurator-DP (the available version depends on the CPU type) is required.

Configuration software ProfiMap and GX Configurator-DP are not compatible with each other and not subject to automatic conversion.

After checking the parameter settings of the existing module with configuration software ProfiMap, the parameters need to be re-set with Configurator-DP.

(b) When configuration software GX Configurator-DP is used

After replacement, using the configuration software GX Configurator-DP corresponding to the CPU type, the master module model name is selected and changed to the replacement module model name. By doing this, the parameters of the existing module can be diverted to the project file for QJ71PB92V (QJ71PB92D compatibility function).

This eliminates the need for new setting.

☒ Point

The master module model name of GX Configurator-DP is selected and changed according to the following procedure.

- GX Configurator-DP menu [File] → [Change Master Type]

Example: For GX Configurator-DP7.01B

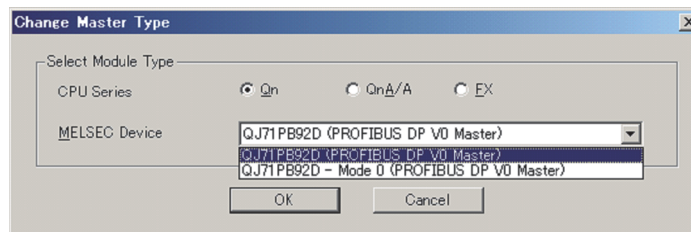

For details including the method of setting with configuration software, refer to the manual of the configuration software used.

Example: For GX Configurator-DP Version 7

GX Configurator-DP Version7 Operating Manual

(2) Data consistency function

The data consistency function guarantees data integrity when input data is read from each slave node to the CPU device or when the CPU device is written to the output data of each slave node.

The data consistency function of existing AJ71PB92D/A1SJ71PB92D is implemented by reading/writing data with the FROM/TO instructions. Alternative module QJ71PB92V (QJ71PB92D compatibility function) implements that function in one of the following. Program correction or creation is required.

(a) Implementing data consistency using the dedicated instructions

Delete the existing FROM/TO instructions and create a new sequence program which reads/writes data using the dedicated instructions.

- Dedicated instruction for reading input data: BBLKRD
- Dedicated instruction for writing output data: BBLKWR

The dedicated instructions read or write I/O data while keeping data consistency.

For details of the dedicated instructions, refer to the "QJ71PB92D/QJ71PB92V (QJ71PB92D compatibility function) PROFIBUS-DP Interface Module User's Manual".

(b) Implementing data consistency using the auto refresh function

Delete the existing FROM/TO instructions and set the parameters for the auto refresh function using GX Configurator-DP.

The auto refresh function set by parameters read or write I/O data while keeping data consistency.

Point

For details of the auto refresh function and dedicated instructions for data consistency, refer to the "QJ71PB92D/QJ71PB92V (QJ71PB92D compatibility function) PROFIBUS-DP Interface Module User's Manual".

(3) Notes on diverting sequence programs

(a) Data consistency program

As written in (2), delete the FROM/TO instructions read/write I/O data, and replace them with the auto refresh function set by parameters or the dedicated instructions.

Note that when changing to the dedicated instructions, a program which turns on the signal "Y0C" to enable the dedicated instructions need to be created additionally.

If data consistency is not taken into consideration, existing programs can be used without modification.

(b) Input/output signals XY

- Watchdog timer error signal

Watchdog timer error signals are assigned differently as follows.

Existing programs need to be modified when diverted.

Signal name	AJ71PB92D/A1SJ71PB92D	QJ71PB92V (QJ71PB92D compatibility function)
Watchdog timer error signal	X0D	X1F

(c) Buffer memory address

The buffer memory configurations of the existing module and alternative module are the same except the own node number storage area, which is an additional function.

The FROM/TO instructions of the existing program do not need to be modified.

Note that the LED indication for the check of the own node number has been changed to the confirmation data stored in buffer memory.

To check the own node number, create a program which reads "own node number display area: 2257 (8D1H)" added in the buffer memory.

9.3 PROFIBUS-DP Slave Module Replacement

9.3.1 Performance specifications comparison

○: Compatible △: Partly changed ×: Incompatible

Item	AnS series	Q series module	Compat- ibility	Precautions for replacement	
	A1SJ71PB93D	QJ71PB93D			
PROFIBUS-DP station type	Slave station (Complies with EN50170 Volume 2 (Part 1, 2, 3, 4, 8))		○		
Station numbers that may be set	0 to 125		○		
Max. number of data that may be communicated	Number of I/O data is 192 words in total. (Size of I/O data is up to 122 words.)		○		
Transmission specifications	Electrical standard/ characteristics	Complies with EIA-RS485		○	
	Medium	Shielded twisted pair cable		○	When diverting the existing cable, use a connector with built-in terminating resistor.*2
	Terminating resistor	Mounted by user (terminal node only)		○	
	Network topology	Bus topology (Tree topology when repeaters are used)		○	
	Data link method	Polling method		○	
	Encoding method	NRZ		○	
	Transmission speed	9.6kbps to 12Mbps*1		○	
	Transmission distance	Differs depending on the transmission speed*1		○	
	Max. No. of repeaters	3 repeaters		○	
Number of connectable modules (Per segment)	32 modules (including repeaters)		○		
Flash ROM write count	Max. 10,000 times		○		
Number of occupied I/O points	32 points (I/O assignment : 32 special points)	32 points (I/O assignment: 32 intelligent points)	○		
5VDC internal current consumption	0.36A	0.44A	△	5VDC internal current consumption needs to be recalculated.	
Weight	0.18kg	0.11kg	○		

*1 For details of the transmission speed and transmission distance, refer to Section 9.2.1.

*2 For details of the terminating resistor, refer to Section 9.2.1.

9.3.2 Function list

Item	Description	AnS	Q	Precautions for replacement							
I/O data communication function	<p>This function works as a PROFIBUS-DP slave station to communicate I/O data with the class 1 master station.</p> <p>Communication of the following number of points is possible per module.</p> <ul style="list-style-type: none"> • Input data: Max. 122 words • Output data: Max. 122 words <p style="text-align: right;">} Max. total: 192 words</p>	○	○								
Global control function	By sending services (SYNC, UNSYNC, FREEZE, UNFREEZE) to each DP-Slave in a group, synchronous control of DP-Slave I/O data is available.	○	○								
Data swap function	This function swaps the upper and lower bytes in word units when I/O data is sent and received.	○	○								
Data consistency function	When I/O data are read from or written to the buffer memory, this function prevents the I/O data from being separated and incorrectly mixed.			For prevention of data inconsistency, change the FROM/TO instructions to auto refresh setting or dedicated instructions.							
	• Automatic refresh setting (GX Configurator-DP)	-	○								
	• FROM/TO instructions	○	-								
Operation mode	Set the operation mode.										
	<table border="1" style="width: 100%;"> <tr> <td style="width: 20%;">Normal operation mode</td> <td>The slave parameters that have been set in the master station are used for communication. Communication is enabled when the slave parameters are within the setting ranges. (Setting only a station number)</td> <td style="text-align: center;">○</td> <td style="text-align: center;">○</td> </tr> <tr> <td>Self-diagnosis mode</td> <td>Hardware failure diagnostics is performed in standalone mode. Communication with the master station is not performed.</td> <td style="text-align: center;">○</td> <td style="text-align: center;">○</td> </tr> </table>	Normal operation mode	The slave parameters that have been set in the master station are used for communication. Communication is enabled when the slave parameters are within the setting ranges. (Setting only a station number)	○	○	Self-diagnosis mode	Hardware failure diagnostics is performed in standalone mode. Communication with the master station is not performed.	○	○		
Normal operation mode	The slave parameters that have been set in the master station are used for communication. Communication is enabled when the slave parameters are within the setting ranges. (Setting only a station number)	○	○								
Self-diagnosis mode	Hardware failure diagnostics is performed in standalone mode. Communication with the master station is not performed.	○	○								
Setting by configurator software	Slave parameters and I/O data auto refresh can be set with configurator software GX Configurator-DP.	-	○	Configurator software GX Configurator-DP makes setting easy although it is not required.							

9.3.3 Parameter Setting to Master Station

The QJ71PB93D GSD file and parameters need to be written to the master station using configurator software.

If QJ71PB93D GSD file and parameters have already been written to the master station, they do not need to be written again.

For details of setting method, refer to the manual of configurator software GX Configurator-DP used.

Item	Description
Station No. (FDL Address)	Set the station number of A1SJ71PB93D/QJ71PB93D. Setting range: 0 to 125
Communication watch dog timer (Watchdog)	Set the watchdog timer period of the communication watchdog timer. The A1SJ71PB93D/QJ71PB93D detects a communication error if data cannot be received from the master station within the configured time. If the communication watchdog timer has not been set, no error is detected. Setting range: 2 to 65025 (set value × 10ms)
Minimum response time (min T_sdr)	Set the minimum response time during which the response frame is sent from the A1SJ71PB93D/QJ71PB93D to the master station. Usually the default value is used. Setting range: 1 to 255
Group identification number (Group identification number)	Specify groups (Grp1 to Grp8) to which the A1SJ71PB93D/QJ71PB93D belongs. Multiple groups (Grp1 to Grp8) can be set.
Data module setting	Set the I/O configuration information (set to "Cfg_Data" of the master station) <ul style="list-style-type: none"> • Setting type: 96 patterns • Number of setting: 1 to 40
Data assignment mode setting	Set the data layout of the output receive area/input send area of the buffer memory (set to "User_Prm_Data" of the master station) <ul style="list-style-type: none"> • Setting range 0: LUMP mode (default) 1: DIVIDED mode
Swap setting	Set whether the word data sent/received on the A1SJ71PB93D/QJ71PB93D side will be swapped or not (set to "User_Prm_Data" of the master station) <ul style="list-style-type: none"> • Setting range 0: Without swap (default) 1: With swap

9.3.4 Input/output signal comparison

(1) Input signal

Of the input signals, the "watchdog timer error signal" changes from X0D of A1SJ71PB93D to "X00" of QJ71PB93D. Existing programs need to be corrected when diverted.

Input signal	Signal name		Compat- ibility	Remarks
	A1SJ71PB93D	QJ71PB93D		
X00	Use prohibited	Watchdog timer error	×	The device numbers of the same function are different.
X01	I/O communication signal		○	
X02	Extension trouble notification completion signal		○	
X03	Module error signal		○	
X04	Use prohibited		-	
X05	SYNC mode signal		○	
X06	SYNC receive signal		○	
X07	FREEZE mode signal		○	
X08	Use prohibited		-	
X09				
X0A	Use prohibited	BBLKRD start request acceptance completion signal	△	Dedicated instruction compatible signal added to QJ71PB93D
X0B		BBLKWR start request acceptance completion signal	△	
X0C		Use prohibited	Use prohibited	-
X0D	×			The device numbers of the same function are different.
X0E	-			
X0F	-			
X10				
X11	Operation mode change completion signal		○	
X12	Use prohibited		○	
X13	Station number change completion signal		○	
X14	Use prohibited		-	
X15				
X16				
X17				
X18				
X19				
X1A				
X1B				
X1C				
X1D	Module READY signal		○	
X1E	Use prohibited		-	
X1F				

(2) Output signal

The output signals of A1SJ71PB93D and QJ71PB93D are the same except the function of "Y0A/0B: dedicated instruction compatible signal" that has been added. Existing programs do not need to be corrected when diverted (dedicated instructions are not used).

Output signal	Signal name		Compat-ibility	Remarks
	A1SJ71PB93D	QJ71PB93D		
Y00	Input send area refresh directive signal		○	
Y01	Use prohibited		○	
Y02	Extension trouble notification request signal		○	
Y03	Module error reset request signal		○	
Y04	Use prohibited	Use prohibited	-	
Y05				
Y06				
Y07				
Y08				
Y09		BBLKRD start request signal	△	Dedicated instruction compatible signal added to QJ71PB93D
Y0A		BBLKWR start request signal	△	
Y0B		Use prohibited	-	
Y0C				
Y0D				
Y0E				
Y0F				
Y10				
Y11	Operation mode change request signal		○	
Y12	Use prohibited		○	
Y13	Station number change request signal		○	
Y14	Use prohibited		-	
Y15				
Y16				
Y17				
Y18				
Y19				
Y1A				
Y1B				
Y1C				
Y1D				
Y1E				
Y1F				

9.3.5 Buffer memory comparison

Address Decimal (hexadecimal)	Description		Compat- ibility	Precautions for replacement
	A1SJ71PB93D	QJ71PB93D		
0000 to 0191 (000H to 0BFH)	Output receive area (Stores the output data received from the master station. (Max. usable range 122 words))		○	
0192 to 0255 (0C0H to 0FFH)	System area (Use prohibited)		○	
0256 to 0447 (100H to 1BFH)	Input send area (Used to set the input data to be sent to the master station. (Max. usable range 122 words))		○	
0448 to 0511 (1C0H to 1FFH)	System area (Use prohibited)		-	
0512 (200H)	Operation baud rate (Stores the baud rate in current operation.)		○	
0513 (201H)	Operation station number (Stores the station number in current operation.)		○	
0514 (202H)	Station number set on flash ROM (Stores the station number saved on the flash ROM.)		○	
0515 (203H)	Station number change request area (Used to set a new station number to be set in response to the station number change request signal (Y13).)		○	
0516 (204H)	Station number rewritable count to flash ROM (Stores the remaining number of times when the station number can be saved onto the flash ROM during continuous operation.)		○	
0517 to 2039 (205H to 7F7H)	System area (Use prohibited)		-	
2040 (7F8H)	Module error information (Stores the error code detected by the A1SJ71PB93D/QJ71PB93D.)		○	
2041 to 2053 (7F9H to 805H)	Extension trouble information area (Used to set the extension trouble notification data to the master station.)		○	
2054 to 2253 (806H to 8CDH)	System area (Use prohibited)		-	
2254 (8CEH)	Current operation mode (Stores the operation mode in current operation.)		○	
2255 (8CFH)	Operation mode change request area (Used to set a new operation mode to be set in response to the operation mode change request signal (Y11).)		○	
2256 (8D0H)	Operation mode change result (Stores the result of changing the operation mode in response to the operation mode change request signal (Y11).)		○	
2257 (8D1H)	Current communication watchdog timer value (Stores the communication watchdog timer value in current operation.)		○	
2258 (8D2H)	System area (Use prohibited)	Self-diagnostic status type code display area (Stores the diagnostic status type code at the time of self-diagnostics.)	△	This area has been added to QJ71PB93D.
2259 (8D3H)	Swapping function setting status (Stores the setting status of the swapping function in current operation.)		○	
2260 to 2271 (8D4H to 8DFH)	System area (Use prohibited)		-	
2272 to 2283 (8E0H to 8EBH)	Output receive area used status (Stores the current used status of the output receive area.)		○	
2284 to 2287 (8ECH to 8EFH)	System area (Use prohibited)		-	
2288 to 2299 (8F0H to 8FBH)	Input send area used status (Stores the current used status of the input send area.)		○	
2300 to 2815 (8FCH to AFFH)	System area (Use prohibited)		-	

9.3.6 Program diversion

This section describes the methods of diverting parameters and programs when replacing the existing A1SJ71PB93D with QJ71PB93D.

(1) Slave parameter setting

The parameters of the existing module can be diverted by selecting/changing the slave module model name to the alternative module model name using the configuration software GX Configurator-DP. When configuration software GX Configurator-DP is used, a program for setting slave parameters is required.

(2) GSD (DDB) file/parameter setting to Master Station

(a) In the case of a master station which can use configuration software GX Configurator-DP

The QJ71PB93D GSD file has already been incorporated into the configuration software GX Configurator-DP.

The GSD file is thus not needed to be installed.

(b) When configurator software in the master station of another company

Contact your nearest branch or agency for the QJ71PB93D GSD (DDB) file.

(3) Data consistency function

The data consistency function guarantees data integrity when I/O data with the master station is read or written.

The data consistency function of existing A1SJ71PB93D is implemented by reading/writing data with the FROM/TO instructions. Alternative module QJ71PB93D implements that function in one of the following.

Program correction or creation is required.

(a) Implementing data consistency using the dedicated instructions

Delete the existing FROM/TO instructions and create a new sequence program which reads/writes data using the dedicated instructions.

- Dedicated instruction for reading input data: BBLKRD
- Dedicated instruction for writing output data: BBLKWR

The dedicated instructions read or write I/O data while keeping data consistency.

(b) Implementing data consistency using the auto refresh function

Delete the existing FROM/TO instructions and set the parameters for the auto refresh function using GX Configurator-DP.

The auto refresh function set by parameters read or write I/O data while keeping data consistency.

Point

For details of the auto refresh function and dedicated instructions for data consistency, refer to the "PROFIBUS-DP Slave Module User's Manual".

(4) Notes on diverting sequence programs

(a) Data consistency program

As written in (3), delete the FROM/TO instructions read/write I/O data, and replace them with the auto refresh function set by parameters or the dedicated instructions.

Note that when changing to the dedicated instructions, a program which turns on the signal "Y0A/0B" to enable the dedicated instructions need to be created additionally.

If data consistency is not taken into consideration, existing programs can be used without modification.

(b) Input/output signals XY

- Watchdog timer error signal

Watchdog timer error signals are assigned differently as follows.

Existing programs need to be modified when diverted.

Signal name	A1SJ71PB93D	QJ71PB93D
Watchdog timer error signal	X0D	X00

(c) Buffer memory address

The buffer memory configurations of the existing module and alternative module are the same except the self-diagnostics status type code display area, which is an additional function.

The FROM/TO instructions of the sequence program do not need to be modified.

10 REPLACEMENT OF OTHER MODULES

Some of the modules other than those introduced in the previous chapters "have no alternative modules" or "are different in functions or specifications" and require consideration of alternatives for replacement to the Q series. This chapter describes these modules.

Product name	Model	Alternative/consideration	Mountability on the QA(1S) extension base unit
Serial communication module (module function)	AJ71QC24N	Consider replacement to the modem function of QJ71C24N(-R2). For details of the modem function, refer to the "MELSEC-Q/L Serial Communication Module User's Manual (Application)"	Not mountable
	AJ71QC24N-R2		
	A1SJ71QC24N1		
	A1SJ71QC24N1-R2		
Memory card/Centronics interface module	AD59(S1)	No Centronics interface module is not available. Consider to change the communication system to such as RS-232. When a memory card is used, set a file register on the memory card or standard RAM for substitution.	Not mountable
Memory card interface module	A1SD59J-S2	When a memory card is used, set a file register on the memory card or standard RAM for substitution.	Not mountable
ID interface module	AD35ID1	There is no alternative model. Consider to change to products from partner manufacturers (ID system BIS M series manufactured by Balluff Inc. or ID system Z series manufactured by B&PLUS KK) For details, refer to "Technical bulletin: FA-A-0062".	Mountable
	AD35ID2		
	A1SD35ID1		
	A1SD35ID2		

APPENDICES

Appendix 1 External Dimensions

For the external dimensions of each module described in this handbook, refer to the user's manual of each module.

Appendix 2 Spare Parts Storage

- (1) The general specifications of programmable controllers are as follows. Please do not store spare parts under a high temperature or high humidity condition, even within the range guaranteed by the specifications.

Storage ambient temperature	-20 to 75 °C
Storage ambient humidity	10 to 90%, no condensation

- (2) Store in a place avoiding direct sunlight.
- (3) Store under a condition with no dust or corrosive gas.
- (4) The capacity of the batteries (such as an A6BAT battery and an A8BAT battery) or a lithium coin battery (commercially available) for memory card is decreased by its self-discharging even when it is not used. Replace it with new one in 5 years as a guideline.
- (5) Among power supply modules or CPU modules with built-in power supply that use any aluminum electrolytic capacitor, the characteristics of the modules listed below will be deteriorated if they are left un-energized for a long time. Therefore, take the following measures.

Product	Model
CPU module (Power supply built-in type)	A1NCPUR21, A1NCPUP21, A1NCPUP21-S3, A2CCPUR21, A2CCPUP21, A2CCPUC24, A2CCPUC24-PRF, A2CJCPU-S3 A1SJHCPU
Power supply module	A61P, A61PEU, A61P-UL, A62P, A62PEU, A63P, A68P, A61RP, A67RP, A2CJ66P A1S61PN, A1S62PN, A1S63P
Analog module	A62DA, A62DA-S1 A1S64AD, A1S68AD, A1S62DA, A1S68DAI, A1S68DAV, A1S63ADA, A1S66ADA

[Measures for preventing aluminum electrolytic capacitor characteristics deterioration]

Apply the rated voltage to the aluminum electrolytic capacitor for several hours to activate it. Or, rotate products at the periodic inspection (in every 1 to 2 years).

[Reference]

The life of an aluminum electrolytic capacitor, even if not used and under a normal temperature, decreases approximately 4 times slowly than the case when it is energized.

Appendix 3 Procedure for Replacing the A1SD51S with the QD51(-R24)

The following is the procedure for replacing the A1SD51S with the QD51(-R24).

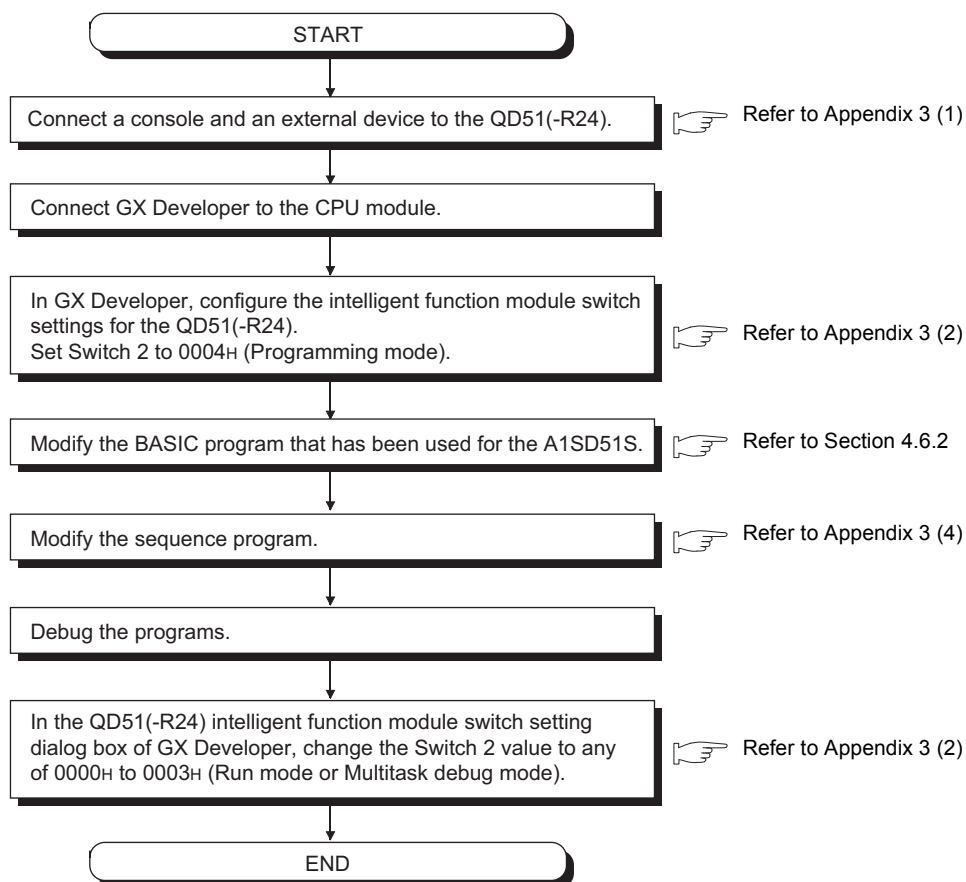

(1) Connecting a console and an external device to the QD51(-R24)

(a) Connection to the RS-232 interface

Since the same RS-232 interface specifications are applied to the QD51(-R24) and the A1SD51S, the existing cable and RS-232 converter can be reused.

(b) Connection to the RS-422/485 interface

Because the QD51(-R24) uses a two-piece terminal block, the existing connector for the A1SD51S cannot be reused. In addition, wiring must be checked and changed since the signals are assigned to different positions.

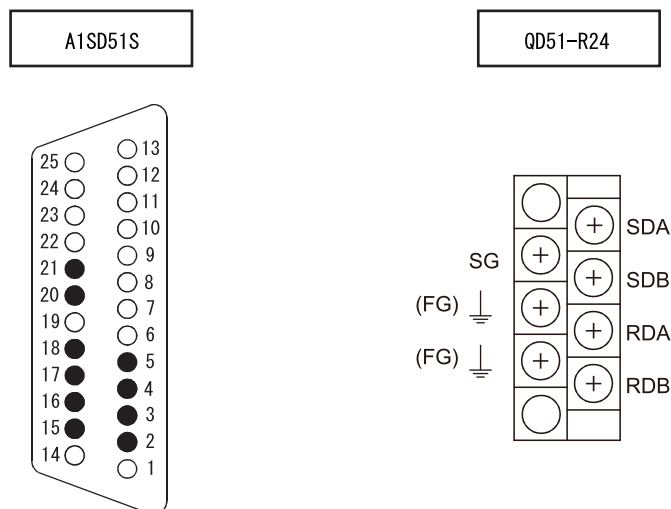

For connection details, refer to the Q Corresponding Intelligent Communication Module User's Manual, "RS-232 Interface Specifications".

(2) Setting the mode

The mode of the QD51(-R24) is set in the intelligent function module setting dialog box of GX Developer while the mode of the A1SD51S is set with the mode setting switch on the module.

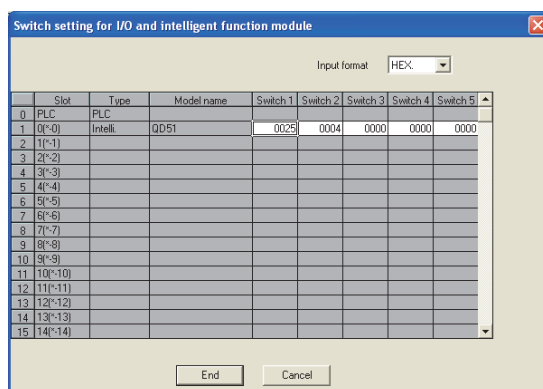

(a) Switch 1

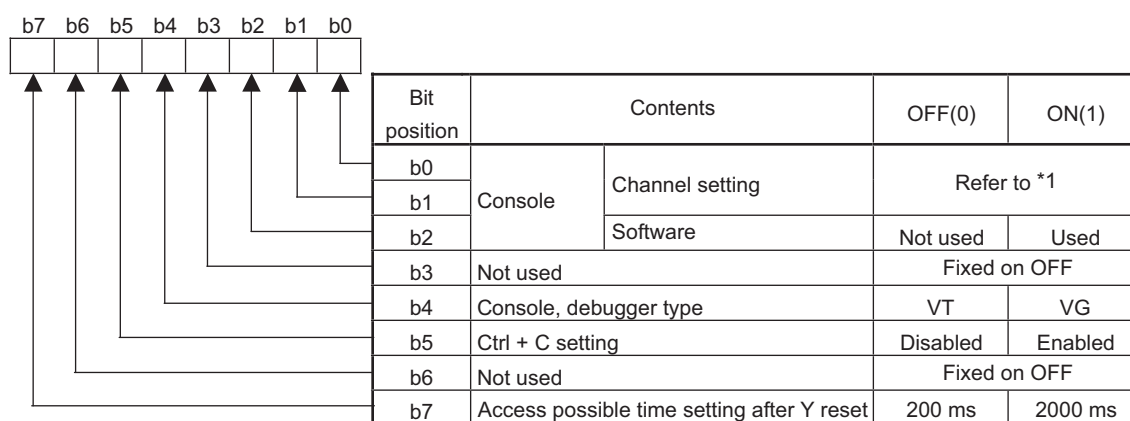

*1 Console (Channel setting)

Bit position		Contents
b1	b0	
OFF	OFF	Without console
OFF	ON	With console CH.1
ON	OFF	With console CH.2
ON	ON	Setting impossible

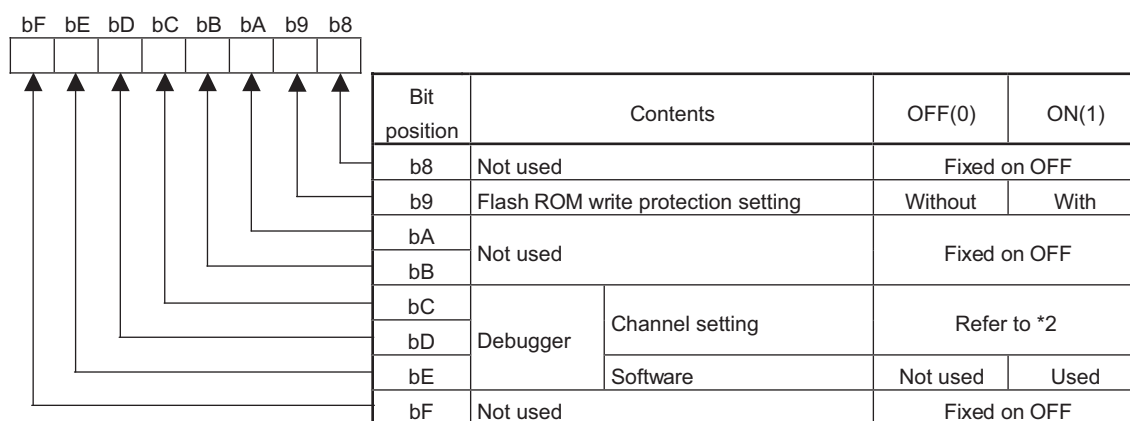

*2 Debugger (Channel setting)

Bit position		Contents
bD	bC	
OFF	OFF	Without a debugger
OFF	ON	With debugger CH.1
ON	OFF	With debugger CH.2
ON	ON	Setting impossible

(b) Switch 2

Set value	Description	Remark
0000 _H	Run mode	Mode for executing the BASIC program.
0001 _H		
0002 _H	Multitask debug mode	Mode for debugging by connecting a debugger.
0003 _H		
0004 _H	Programming mode	Mode for programming by connecting a console.
0005 _H to 000F _H	Setting prohibited	-

(c) Switch 3 to Switch 5

Set 0000_H.

(3) Modifying the BASIC program used for the A1SD51S

Programs used for the A1SD51S can be utilized for the QD51(-R24).

However, modification of the BASIC program may be required since the following setting items may be different between these models.

(4) Modifying the sequence program

When the Task start signal (Y19) has been used to start a task, add the YCHECK instruction in the sequence program.

On the A1SD51S, an interrupt occurs upon turn-ON of the Task start signal (Y19), which starts a task.

The QD51(-R24) monitors the Task start signal (Y19) at intervals of 10ms for starting a task.

By executing the YCHECK command as shown below, the task can be started at the same timing as the A1SD51S.

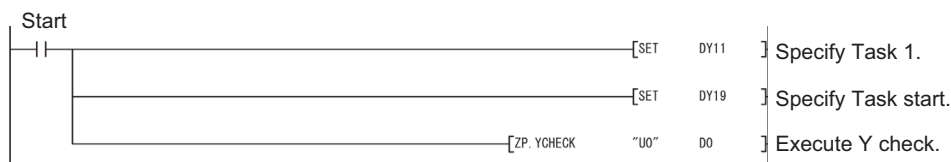

Appendix 4 Relevant Manuals

Appendix 4.1 Replacement Handbooks

(1) Transition Guide

No.	Manual name	Manual No.	Model code	
			A (Large Type)	AnS (Small Type)
1	Mitsubishi Programmable Controllers MELSEC-A/QnA Series Transition Guide	L08077E	○	×
2	Mitsubishi Programmable Controllers MELSEC-AnS/QnAS Series Transition Guide	L08236E	×	○

(2) Replacement Handbooks

No.	Manual name	Manual No.	Model code	
			A (Large Type)	AnS (Small Type)
1	Transition from MELSEC-A/QnA (Large Type) Series to Q Series Handbook (Fundamentals)	L08043ENG	○	×
	Transition from MELSEC-AnS/QnAS (Small Type) Series to Q Series Handbook (Fundamentals)	L08219ENG	×	○
2	Transition from MELSEC-A/QnA (Large Type) Series to Q Series Handbook (Intelligent Function Modules)	L08046ENG	○	×
	Transition from MELSEC-AnS/QnAS (Small Type) Series to Q Series Handbook (Intelligent Function Modules)	L08220ENG	×	○
3	Transition from MELSEC-A/QnA (Large Type), AnS/QnAS Series (Small Type) to Q Series Handbook (Network Modules)	L08048ENG	○	○
4	Transition from MELSEC-A/QnA (Large Type) Series, AnS/QnAS Series (Small Type) to Q Series Handbook (Communications)	L08050ENG	○	○
5	Transition from MELSEC-A0J2H Series to Q Series Handbook	L08060ENG	○	○
6	Transition from MELSECNET/MINI-S3, A2C (I/O) to CC-Link Handbook	L08061ENG	○	○
7	Transition from MELSEC-I/OLINK to CC-Link/LT Handbook	L08062ENG	○	○
8	Transition from MELSEC-I/OLINK to AnyWire DB A20 Handbook	L08263ENG	○	○
9	Transition of CPUs in MELSEC Redundant System Handbook (Transition from Q4ARCPU to QnPRHCPU)	L08117ENG	○	×

(3) Transition Examples

No.	Manual name	Manual No.	Model code	
			A (Large Type)	AnS (Small Type)
1	MELSEC-A/QnA (Large), AnS/QnAS (Small) Transition Examples	L08121E	○	○

(4) Others

No.	Manual name	Manual No.	Model code	
			A (Large Type)	AnS (Small Type)
1	Product discontinuation of the A1SD51S intelligent communication module	FA-A-0059	×	○
2	Procedures for Replacing Positioning Module AD71 with QD75	FA-A-0060	○	×
3	Precautions for replacing A/QnA (large type) series CPU with Universal model QCPU	FA-A-0068	×	○
4	Product discontinuation of ID system D-2N series	FA-A-0062	○	○

Appendix 4.2 A/AnS series

No.	Manual name	Manual No.	Model code
1	Computer Link Module Guidebook	SH-3510	13JE76
2	Computer Link Module User's Manual (Com.link func./Print.func.)	SH-3511	13JE77
3	type AJ71C22S1 User's Manual	IB-66269	13J789
4	For A Ethernet Interface Module User's Manual	SH-080192	13JR45
5	Intelligent communication module type AD51H-S3 User's Manual	IB-66401	13JE16
6	Type A1SD51S Intelligent communication module User's Manual	IB-66551	13JE90
7	Intelligent Communication Module type AD51-S3 User's Manual	IB-66189	13J655
8	GPC-BASIC SUPPLEMENTARY	IB-66214	13J766
9	GPC-BASIC SUPPLEMENTARY	IB-66100	13J636
10	AD51H-BASIC Programming Manual (Command)	SH-080090	13JF63
11	AD51H-BASIC Programming Manual (Debug and Compile)	SH-080091	13JF64
12	AS-i Master module type A1SJ71AS92 User's Manual	SH-080085	13JR15
13	Serial communication compatible with MODBUS type AJ71UC24-S2/A1SJ71UC24-R2-S2/A1SJ71UC24-R4-S2 User's Manual	IB-66583	13J806
14	Model AJ71DN91/A1SJ71DN91 DeviceNet Master Module User's Manual	SH4004	13JL69
15	PROFIBUS-DP interface module type AJ71PB92D/ A1SJ71PB92D User's Manual	IB-66773	13JL20
16	A1SD59J-S2/MIF Memory Card Interface Module User's Manual	SH-080056	13JR05
17	ID Interface Module type AD35ID1, AD35ID2, A1SD35ID1, A1SD35ID2 User's Manual	SH-080147	13JR35
18	MELSECNET/MINI-S3 Master Module Type AJ71PT32-S3, AJ71T32-S3, A1SJ71PT32-S3, A1SJ71T32-S3 User's Manual	IB-66565	13JE64
19	MELSEC-I/O Link Remote I/O System Master Module type AJ51T64/A1SJ51T64 User's Manual	IB-66574	13J748

Appendix 4.3 QnA/QnAS series

No.	Manual name	Manual No.	Model code
1	Computer Link Module Guidebook	SH-3510	13JE76
2	Serial Communications Module User's Manual (Modem Function Additional Version)	IB-66612	13J825
3	For QnA Ethernet Interface Module User's Manual	SH-080146	13JR33

Appendix 4.4 Q series

No.	Manual name	Manual No.	Model code
1	Q Corresponding Serial Communication Module User's Manual (Basic)	SH-080006	13JL86
2	MELSEC-Q/L Serial Communication Module User's Manual (Application)	SH-080007	13JL87
3	MELSEC Communication Protocol Reference Manual	SH-080008	13JF89
4	Q Corresponding Ethernet Interface Module User's Manual (Basic)	SH-080009	13JL88
5	MELSEC-Q/L Ethernet Interface Module User's Manual (Application)	SH-080010	13JL89
6	MELSEC-Q/L Ethernet Interface Module User's Manual (Web function)	SH-080180	13JR40
7	GX Configurator-SC Version 2 Operating Manual (Protocol FB support function)	SH-080393E	13JU46
8	Q Corresponding Intelligent Communication Module User's Manual	SH-080089	13JR16
9	AD51H-BASIC Programming Manual (Command)	SH-080090	13JF63
10	AD51H-BASIC Programming Manual (Debug and Compile)	SH-080091	13JF64
11	MODBUS(R) Interface Module User's Manual	SH-080578ENG	13JR86
12	MODBUS(R)/TCP Interface Module User's Manual	SH-080446ENG	13JR71
13	AS-i Master Module User's Manual QJ71AS92 GX Configurator-AS (SW1D5C-QASU-E)	SH-080291E	13JR53
14	DeviceNet Master-Slave Module User's Manual	SH-080143	13JR32
15	PROFIBUS-DP Interface Module User's Manual	SH-080127	13JR22
16	PROFIBUS-DP Slave Module User's Manual	SH-080318E	13JR57

WARRANTY

Please confirm the following product warranty details before using this product.

1. Gratis Warranty Term and Gratis Warranty Range

If any faults or defects (hereinafter "Failure") found to be the responsibility of Mitsubishi occurs during use of the product within the gratis warranty term, the product shall be repaired at no cost via the sales representative or Mitsubishi Service Company.

However, if repairs are required onsite at domestic or overseas location, expenses to send an engineer will be solely at the customer's discretion. Mitsubishi shall not be held responsible for any re-commissioning, maintenance, or testing on-site that involves replacement of the failed module.

[Gratis Warranty Term]

The gratis warranty term of the product shall be for one year after the date of purchase or delivery to a designated place. Note that after manufacture and shipment from Mitsubishi, the maximum distribution period shall be six (6) months, and the longest gratis warranty term after manufacturing shall be eighteen (18) months. The gratis warranty term of repair parts shall not exceed the gratis warranty term before repairs.

[Gratis Warranty Range]

- (1) The range shall be limited to normal use within the usage state, usage methods and usage environment, etc., which follow the conditions and precautions, etc., given in the instruction manual, user's manual and caution labels on the product.
- (2) Even within the gratis warranty term, repairs shall be charged for in the following cases.
 1. Failure occurring from inappropriate storage or handling, carelessness or negligence by the user. Failure caused by the user's hardware or software design.
 2. Failure caused by unapproved modifications, etc., to the product by the user.
 3. When the Mitsubishi product is assembled into a user's device, Failure that could have been avoided if functions or structures, judged as necessary in the legal safety measures the user's device is subject to or as necessary by industry standards, had been provided.
 4. Failure that could have been avoided if consumable parts (battery, backlight, fuse, etc.) designated in the instruction manual had been correctly serviced or replaced.
 5. Failure caused by external irresistible forces such as fires or abnormal voltages, and Failure caused by force majeure such as earthquakes, lightning, wind and water damage.
 6. Failure caused by reasons unpredictable by scientific technology standards at time of shipment from Mitsubishi.
 7. Any other failure found not to be the responsibility of Mitsubishi or that admitted not to be so by the user.

2. Onerous repair term after discontinuation of production

- (1) Mitsubishi shall accept onerous product repairs for seven (7) years after production of the product is discontinued. Discontinuation of production shall be notified with Mitsubishi Technical Bulletins, etc.
- (2) Product supply (including repair parts) is not available after production is discontinued.

3. Overseas service

Overseas, repairs shall be accepted by Mitsubishi's local overseas FA Center. Note that the repair conditions at each FA Center may differ.

4. Exclusion of loss in opportunity and secondary loss from warranty liability

Regardless of the gratis warranty term, Mitsubishi shall not be liable for compensation to:

- (1) Damages caused by any cause found not to be the responsibility of Mitsubishi.
- (2) Loss in opportunity, lost profits incurred to the user by Failures of Mitsubishi products.
- (3) Special damages and secondary damages whether foreseeable or not, compensation for accidents, and compensation for damages to products other than Mitsubishi products.
- (4) Replacement by the user, maintenance of on-site equipment, start-up test run and other tasks.

5. Changes in product specifications

The specifications given in the catalogs, manuals or technical documents are subject to change without prior notice.

Ethernet is a registered trademark of Fuji Xerox Co., Ltd. in Japan

Microsoft and Windows are either registered trademarks or trademarks of Microsoft Corporation in the United States and/or other countries.

Unicode is either a registered trademark or a trademark of Unicode, Inc. in the United States and other countries.

The company names, system names and product names mentioned in this manual are either registered trademarks or trademarks of their respective companies.

In some cases, trademark symbols such as [™] or [®] are not specified in this manual.

Mitsubishi Programmable Controller

Country/Region	Sales office	Tel/Fax
USA	MITSUBISHI ELECTRIC AUTOMATION, INC. 500 Corporate Woods Parkway, Vernon Hills, IL 60061, U.S.A.	Tel : +1-847-478-2100 Fax : +1-847-478-2253
Mexico	MITSUBISHI ELECTRIC AUTOMATION, INC. Mexico Branch Mariano Escobedo #69, Col. Zona Industrial, Tlalnepantla Edo. Mexico, C.P.54030	Tel : +52-55-3067-7500
Brazil	MITSUBISHI ELECTRIC DO BRASIL COMÉRCIO E SERVIÇOS LTDA. Avenida Adelino Cardana, 293, 21 andar, Bethaville, Barueri SP, Brazil	Tel : +55-11-4689-3000 Fax : +55-11-4689-3016
Germany	MITSUBISHI ELECTRIC EUROPE B.V. German Branch Mitsubishi-Electric-Platz 1, 40882 Ratingen, Germany	Tel : +49-2102-486-0 Fax : +49-2102-486-1120
UK	MITSUBISHI ELECTRIC EUROPE B.V. UK Branch Travellers Lane, Hatfield, Hertfordshire, AL10 8XB, U.K.	Tel : +44-1707-28-8780 Fax : +44-1707-27-8695
Ireland	MITSUBISHI ELECTRIC EUROPE B.V. Irish Branch Westgate Business Park, Ballymount, Dublin 24, Ireland	Tel : +353-1-4198800 Fax : +353-1-4198890
Italy	MITSUBISHI ELECTRIC EUROPE B.V. Italian Branch Centro Direzionale Colleoni-Palazzo Sirio Viale Colleoni 7, 20864 Agrate Brianza(Milano) Italy	Tel : +39-039-60531 Fax : +39-039-6053-312
Spain	MITSUBISHI ELECTRIC EUROPE, B.V. Spanish Branch Carretera de Rubí, 76-80-Apdo. 420, 08190 Sant Cugat del Vallés (Barcelona), Spain	Tel : +34-935-65-3131 Fax : +34-935-89-1579
France	MITSUBISHI ELECTRIC EUROPE B.V. French Branch 25, Boulevard des Bouvets, 92741 Nanterre Cedex, France	Tel : +33-1-55-68-55-68 Fax : +33-1-55-68-57-57
Czech Republic	MITSUBISHI ELECTRIC EUROPE B.V. Czech Branch Avenir Business Park, Radlicka 751/113e, 158 00 Praha5, Czech Republic	Tel : +420-251-551-470 Fax : +420-251-551-471
Poland	MITSUBISHI ELECTRIC EUROPE B.V. Polish Branch ul. Krakowska 50, 32-083 Balice, Poland	Tel : +48-12-347-65-00 Fax : +48-12-630-47-01
Sweden	MITSUBISHI ELECTRIC EUROPE B.V. (Scandinavia) Fjellievägen 8, SE-22736 Lund, Sweden	Tel : +46-8-625-10-00 Fax : +46-46-39-70-18
Russia	MITSUBISHI ELECTRIC (RUSSIA) LLC St. Petersburg Branch Piskarevsky pr. 2, bld 2, lit "Sch", BC "Benua", office 720; 195027 St. Petersburg, Russia	Tel : +7-812-633-3497 Fax : +7-812-633-3499
Turkey	MITSUBISHI ELECTRIC TURKEY A.Ş Ümraniye Branch Serifali Mahallesi Nutuk Sokak No:5, TR-34775 Umraniye/Istanbul, Turkey	Tel : +90-216-526-3990 Fax : +90-216-526-3995
UAE	MITSUBISHI ELECTRIC EUROPE B.V. Dubai Branch Dubai Silicon Oasis, P.O.BOX 341241, Dubai, U.A.E.	Tel : +971-4-3724716 Fax : +971-4-3724721
South Africa	ADROIT TECHNOLOGIES 20 Waterford Office Park, 189 Witkoppen Road, Fourways, South Africa	Tel : +27-11-658-8100 Fax : +27-11-658-8101
China	MITSUBISHI ELECTRIC AUTOMATION (CHINA) LTD. No.1386 Hongqiao Road, Mitsubishi Electric Automation Center, Shanghai, China	Tel : +86-21-2322-3030 Fax : +86-21-2322-3000
Taiwan	SETSUYO ENTERPRISE CO., LTD. 6F, No.105, Wugong 3rd Road, Wugu District, New Taipei City 24889, Taiwan	Tel : +886-2-2299-2499 Fax : +886-2-2299-2509
Korea	MITSUBISHI ELECTRIC AUTOMATION KOREA CO., LTD. 7F-9F, Gangseo Hangang Xi-tower A, 401, Yangcheon-ro, Gangseo-Gu, Seoul 07528, Korea	Tel : +82-2-3660-9530 Fax : +82-2-3664-8372
Singapore	MITSUBISHI ELECTRIC ASIA PTE. LTD. 307, Alexandra Road, Mitsubishi Electric Building, Singapore 159943	Tel : +65-6473-2308 Fax : +65-6476-7439
Thailand	MITSUBISHI ELECTRIC FACTORY AUTOMATION (THAILAND) CO., LTD. 12th Floor, SV.City Building, Office Tower 1, No. 896/19 and 20 Rama 3 Road, Kwaeng Bangpongpan, Khet Yannawa, Bangkok 10120, Thailand	Tel : +66-2682-6522 Fax : +66-2682-6020
Vietnam	MITSUBISHI ELECTRIC VIETNAM COMPANY LIMITED Hanoi Branch 6th Floor, Detech Tower, 8 Ton That Thuyet Street, My Dinh 2 Ward, Nam Tu Liem District, Hanoi, Vietnam	Tel : +84-4-3937-8075 Fax : +84-4-3937-8076
Indonesia	PT. MITSUBISHI ELECTRIC INDONESIA Gedung Jaya 11th Floor, JL. MH. Thamrin No.12, Jakarta Pusat 10340, Indonesia	Tel : +62-21-3192-6461 Fax : +62-21-3192-3942
India	MITSUBISHI ELECTRIC INDIA PVT. LTD. Pune Branch Emerald House, EL-3, J Block, M.I.D.C., Bhosari, Pune-411026, Maharashtra, India	Tel : +91-20-2710-2000 Fax : +91-20-2710-2100
Australia	MITSUBISHI ELECTRIC AUSTRALIA PTY. LTD. 348 Victoria Road, P.O. Box 11, Rydalmere, N.S.W 2116, Australia	Tel : +61-2-9684-7777 Fax : +61-2-9684-7245

Mitsubishi Electric Corporation Nagoya Works is a factory certified for ISO 14001 (standards for environmental management systems) and ISO 9001 (standards for quality assurance management systems)

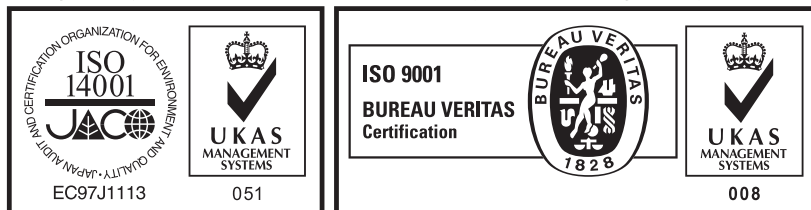

MITSUBISHI ELECTRIC CORPORATION

HEAD OFFICE: TOKYO BUILDING, 2-7-3, MARUNOUCHI, CHIYODA-KU, TOKYO 100-8310, JAPAN
NAGOYA WORKS: 1-14, YADA-MINAMI 5, HIGASHI-KU, NAGOYA, JAPAN